

TX-32DK10F Service Manual

Specifications

Parts List

Safety

Block
Diagrams

Service
Information

Schematic
Diagrams

Exploded
View

PCB
Views

Service Support

Service and repair of this product is supported by Panasonic's LUCI interface.

This interface provides a link between the TV and a standard PC to allow a number of diagnostic and control functions to be performed.

For more details contact your local Panasonic company.

BACK

EXIT

Service Manual



TELEVISORE A COLORI

TX-32DK10F

Telaio EURO-5

Specificazione

Alimentazione:	220-240V a.c., 50Hz	INGRESSO AV2	Video (21 pin)	1V p-p 75Ω
Consumo:	133W		Audio (21 pin)	500mV rms 10kΩ
Consumo in Stand-by:	1,4W		S-Video IN (21-pin)	Y: 1V p-p 75Ω C: 0,3V p-p 75Ω
Impedenza dell'antenna:	75Ω non bilanciata	USCITA AV2	Video (21 pin)	1V p-p 75Ω
System di Ricezione:	CCIR 625 Linee PAL-I, B/G, H, D/K, PAL-525/60 SECAM L/L', B/G, D/K M.NTSC NTSC (Solo ingresso AV)		Audio (21 pin)	500mV rms 1kΩ
Canali Ricezione:		INGRESSO AV3	Uscita selezionabile (21 pin)	
VHF E2-E12	VHF H1-H2 (ITALY)		S-Video IN (4-pin)	Y: 1V p-p 75Ω C: 0,3V p-p 75Ω
VHF A-H (ITALY)	VHF R1-R2	Tensione all'anodo:	Audio (RCAx2)	500mV rms 10kΩ
VHF R3-R5	VHF R6-R12		Video (RCAx1)	1V p-p 75Ω
UHF E21-E69	CATV (S01-S05)	Tube Catodico:		
CATV S1-S10 (M1-M10)	CATV S11-S20 (U1-U10)		Potenza Audio:	2 x 15W Sinistro/Destro 8Ω Impedenza
CATV S21-S41 (HYPER)			Cuffia:	8Ω Impedenza
Frequenze Intermedie:			Accessori:	Telecomando 2 x R6 (UM3) Batterie
Video	38,9MHz, 34MHz	Dimensioni:		
Sound	32,9MHz, 33,16MHz, 33,4MHz 40,4MHz, 32,4MHz (A2 STEREO) 33,05MHz, 34,05MHz (NICAM) 32,66MHz, 32,4MHz (CZECH STEREO)	Altezza:		561mm
Colore	34,47MHz (PAL) 34,5MHz, 34,65MHz (SECAM)	Larghezza:		896mm
		Profondità:		559mm
Prese Video/Audio:		Peso netto:		47kg
USCITA AUDIO MONITOR	Audio (RCAx2) 500mV rms 1kΩ	Le caratteristiche possono variare senza preavviso. Peso e dimensioni sono approssimate.		
INGRESSO AV1	Video (21 pin) 1V p-p 75Ω Audio (21 pin) 500mV rms 10kΩ RVB (21 pin)	NOTA: Per maggiori informazioni consultare la guida tecnica del telaio EURO-5		
USCITA AV1	Video (21 pin) 1V p-p 75Ω Audio (21 pin) 500mV rms 1kΩ			

Indice

Norme di sicurezza.....	2
Consigli per l'assistenza.....	3
Procedura di taratura.....	4
Forma D'onda.....	5
Valori di allineamento.....	6
Schema a blocchi.....	7
Ubicazione Dei Componenti.....	11
Elenco Parti Di Ricambio.....	12
Schema Elettrico.....	26
Vista Lato Componenti.....	31

Norme di sicurezza

Precauzioni

1. E'Consigliabile utilizzare un trasformatore di isolamento prima di eseguire ogni intervento sul telaio.
2. Durante l'assistenza, verificare lo stato dei conduttori specialmente nei circuiti ad alta tensione. In caso di corto circuito, sostituire tutti le parti surriscaldate o danneggiate.
3. Dopo l'assistenza, assicurarsi che tutti gli accorgimenti di protezione (isolatori, schermi, isolatore R-C, ecc) siano correttamente installati.
4. Quando il televisore non viene utilizzato per lunghi periodi, scollegarlo della rete.
5. Alta tensione 32kV è presente quando il televisore è in funzione. Utilizzare il televisore senza il pannello posteriore comporta il pericolo di scosse elettriche dai circuiti di alimentazione. L'assistenza deve essere eseguita solo da personale specializzato a conoscenza delle necessarie precauzioni da adottare. Prima di intervenire sul cinescopio, scaricare a massa l'anodo dello stesso.
6. Dopo l'assistenza assicurarsi di eseguire le seguenti prove di dispersione per prevenire rischi di scossa elettrica all'utente.
4. Verificare ogni parte metallica esterna misurando la tensione ogni volta.
5. Invertire la presa a.c. di alimentazione e ripetere le misure precedenti.
6. Il potenziale in ogni punto non deve superare 1,4V rms, in caso superi questo valore, c'è pericolo di scossa elettrica e il televisore deve essere riparato e controllata prima di essere riconsegnato al proprietario.

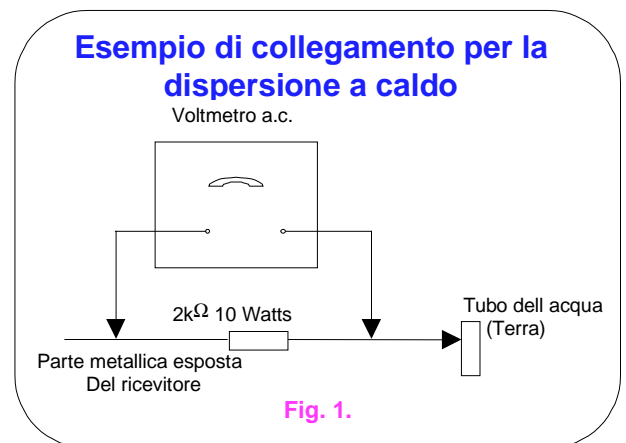

Controllo a freddo di dispersione

1. Disinserire il cavo di alimentazione e corto circuitare i due terminali.
2. Azionare l'interruttore di accensione.
3. Collegare uno strumento per la misure di resistenza con segue un puntale sulla spina del cavo di alimentazione e l'altro sul telaio del televisore o su una parte metallica (ad esempio viti) collegate telaio. Se la parte metallica ha un collegamento col telaio la lettura dovrà essere compresa tra i valori 4MΩ e 20MΩ, se la parte metallica non ha un collegamento con il telaio la lettura dovrà essere.

Controllo a caldo di dispersione

1. Inserire la spina nella presa di corrente. Non usare un trasformatore di isolamento per questo controllo.
2. Collegare una resistenza da 2kΩ 10W in serie con una parte metallica esterna del televisore e con un punto di terra (esempio: tubi dell'acqua).
3. Utilizzare un voltmetro a.c. con sensibilità 1000Ω/Volt o più per misurare il potenziale ai capi della resistenza.

Radiazioni raggi X Precauzioni:

1. La sezione ad alta tensione e il cinescopio sono sorgenti di raggi X.
2. In caso di utilizzo di una sonda per alta tensione, assicurarsi che la stessa sopporti 32kV senza pericolo di emissione di raggi.

NOTA: E'importante verificare periodicamente la funzionalità del misuratore di tensione.

1. Regolare la luminosità al minimo.
2. Misurare l'alta tensione. La lettura dovrà essere 31kV ± 1kV. (se è necessario un immediato intervento tecnico per prevenire danni.)
3. Per prevenire la possibilità di emissione di raggi X, è indispensabile utilizzare il cinescopio specificato.

Consigli per l'assistenza Come rimuovere il pannello posteriore

1. Rimuovere le 10 viti (A) come indicato in Fig. 2.

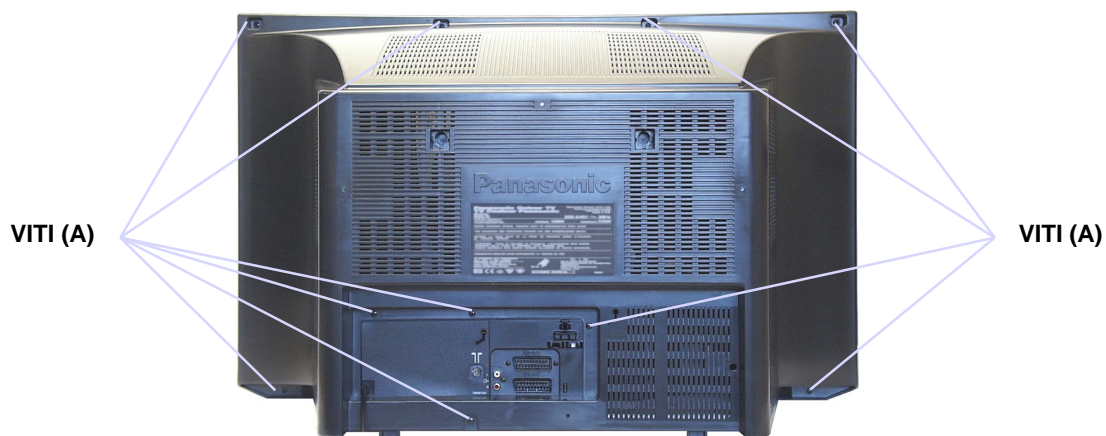

Fig. 2.

Ubicazione dei Controlli

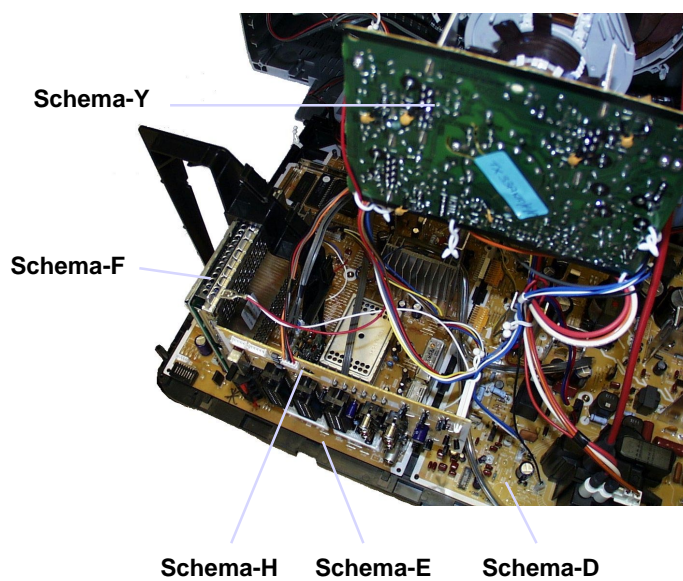

Fig. 3.

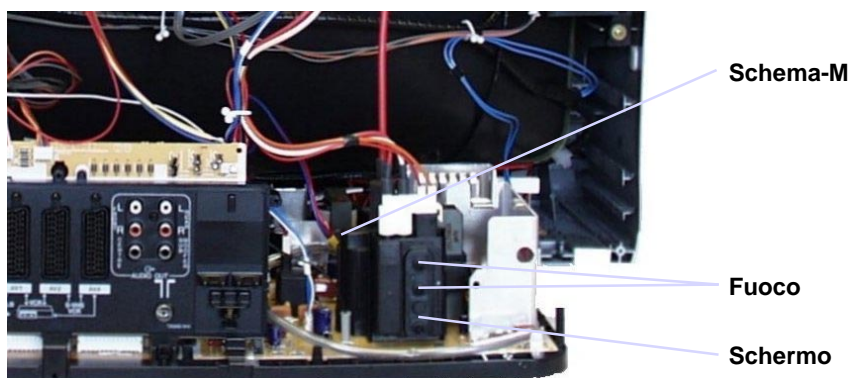

Fig. 4.

Procedura di taratura

TARATURE/PREPARAZIONE	REGOLAZIONE																																								
<p>REGOLAZIONE +B</p> <p>1. Ricevere un segnale a barre colori.</p> <p>2. Predisporre i controlli :- Luminosità minimo</p> <p>Contrasto minimo</p> <p>Volume minimo</p>	<p>1. Confermare le seguenti alimentazioni</p> <table border="0"> <thead> <tr> <th colspan="2">D-Board</th> <th colspan="2">E-Board</th> </tr> </thead> <tbody> <tr> <td>D3, pin5</td> <td>147V ± 3V</td> <td>U8A E19, pin8</td> <td>8V ± 0,5V</td> </tr> <tr> <td>D12, pin5</td> <td>5V ± 0,3V</td> <td>U9 IC3801, pin3</td> <td>9V ± 0,5V</td> </tr> <tr> <td>D13, pin1</td> <td>40V ± 4V</td> <td>U12 E22, pin8</td> <td>12V ± 0,5V</td> </tr> <tr> <td>D3, pin4</td> <td>230V ± 10V</td> <td>STD5V E26, pin4</td> <td>5V ± 0,5V</td> </tr> <tr> <td>D14, pin5</td> <td>5V ± 0,5V</td> <td>U15 E23, pin8</td> <td>15V ± 1V</td> </tr> <tr> <td>D12, pin7</td> <td>15V ± 2V</td> <td>U15 E23, pin9</td> <td>-15V ± 2V</td> </tr> <tr> <td>D12, pin9</td> <td>-15V ± 2V</td> <td>U33 E22, pin10</td> <td>33V ± 4V</td> </tr> <tr> <td>D11, pin8</td> <td>12V ± 2V</td> <td>U40 E24, pin1</td> <td>40V ± 3V</td> </tr> <tr> <td>D11, pin10</td> <td>33V ± 3V</td> <td>U5B E19, pin5</td> <td>5V ± 0,5V</td> </tr> </tbody> </table>	D-Board		E-Board		D3, pin5	147V ± 3V	U8A E19, pin8	8V ± 0,5V	D12, pin5	5V ± 0,3V	U9 IC3801, pin3	9V ± 0,5V	D13, pin1	40V ± 4V	U12 E22, pin8	12V ± 0,5V	D3, pin4	230V ± 10V	STD5V E26, pin4	5V ± 0,5V	D14, pin5	5V ± 0,5V	U15 E23, pin8	15V ± 1V	D12, pin7	15V ± 2V	U15 E23, pin9	-15V ± 2V	D12, pin9	-15V ± 2V	U33 E22, pin10	33V ± 4V	D11, pin8	12V ± 2V	U40 E24, pin1	40V ± 3V	D11, pin10	33V ± 3V	U5B E19, pin5	5V ± 0,5V
D-Board		E-Board																																							
D3, pin5	147V ± 3V	U8A E19, pin8	8V ± 0,5V																																						
D12, pin5	5V ± 0,3V	U9 IC3801, pin3	9V ± 0,5V																																						
D13, pin1	40V ± 4V	U12 E22, pin8	12V ± 0,5V																																						
D3, pin4	230V ± 10V	STD5V E26, pin4	5V ± 0,5V																																						
D14, pin5	5V ± 0,5V	U15 E23, pin8	15V ± 1V																																						
D12, pin7	15V ± 2V	U15 E23, pin9	-15V ± 2V																																						
D12, pin9	-15V ± 2V	U33 E22, pin10	33V ± 4V																																						
D11, pin8	12V ± 2V	U40 E24, pin1	40V ± 3V																																						
D11, pin10	33V ± 3V	U5B E19, pin5	5V ± 0,5V																																						
<p>CUT OFF</p> <p>1. Ricevere un segnale a barre colori.</p> <p>2. Smagnetizzare il cinescopio esternamente.</p> <p>3. Entrare nel SERVICE Mode 1.</p> <p>4. Selezionare CUT-OFF.</p>	<p>Regolare la VR per visualizzare O.K.</p>																																								

SELF CHECK (auto diagnosi)

Il SELF CHECK é usato per testare le linee "BUS" ed il codice esadecimale del TV. Per richiamare il SELF-CHECK occorre premere il tasto di "**STATUS**" sul telecomando e contemporaneamente il tasto (-) sul TV. Attenzione: quando si richiama il Self-check, il TV verrà resettato ritornando alle condizioni di fabbrica, cancellando i canali sintonizzati dal cliente. Sullo schermo apparirà la seguente in tabella :

VPC	O.K.	PCB	O.K.
TUN	O.K.		
E2	O.K.	Cab	O.K.
MSP	O.K.		
DPL	--	Sum	Solo per la fabbrica
CI1	O.K.		
CI2	O.K.		
VP	O.K.		
DFU	O.K.		
COL	--		
PIP	--		
DIS	O.K.		
OPTION 1	B9		
OPTION 2	7D		
OPTION 3	1F		
OPTION 4	80		
OPTION 5	FB		
OPTION 6	23		

Se uno degli ingressi/uscite della "CPU" e' riconosciuta come incorreta, sullo schermo apparirà " -- " invece di " OK ".

Materiale di supporto per l'assistenza TV.

- **LUCI** interface kit (Linked Utility Computer Interface)
Il kit contiene l'interfaccia, i cavi per la connessione al TV e al PC, il software per il diagnostico.
Ogni volta che verrà introdotta una nuova gamma di modelli sarà disponibile il nuovo software aggiornato.
- **VICI** (Visual Interactive Computer Information)
Questi C.D. rom contengono le seguenti informazioni:
 1. Service Manual
 2. Libretti di istruzioni (anche in lingua italiana)
 3. Informazioni tecniche
- **TASMIN** (Technically Advanced System for Multimedia Interactive Notes)
Rappresenta il primo passo per avere informazioni tecniche più velocemente ed in modo interattivo.

NOTA: Questo TV ha l'opzione per utilizzare la "Memory Pack", che vi permette di trasferire i canali sintonizzati nel TV e viceversa. La "Memory Pack" si puo' utilizzare solo con il telaio "EURO-5".

FORMA D'ONDA

NOTA: Tutte le forme d'onda sono state prese usando un segnale a barre colori standard.

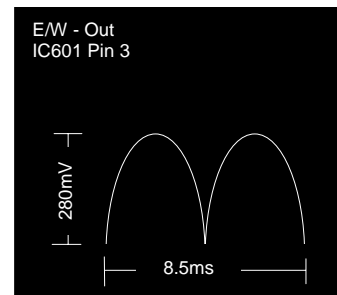
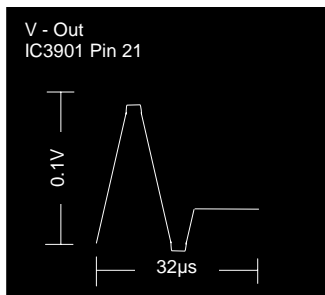
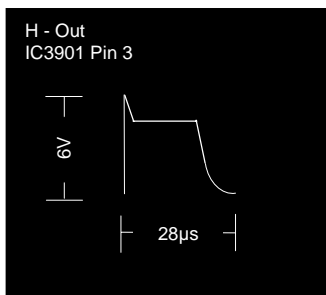
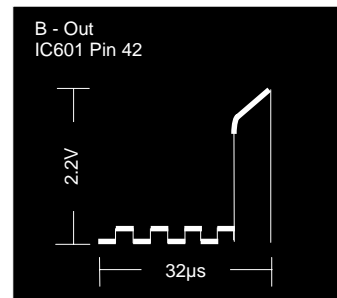
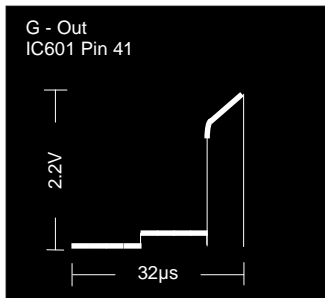
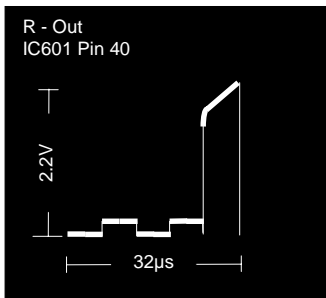
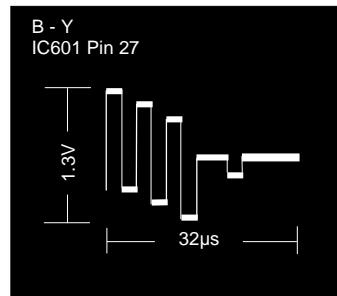
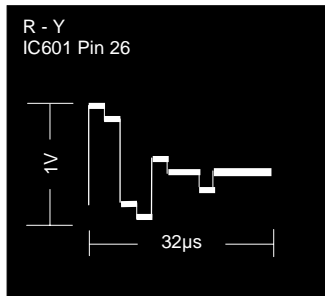
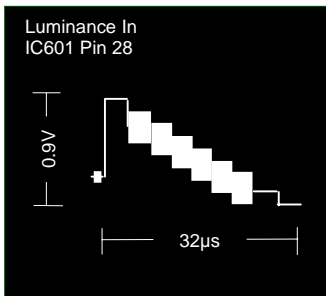
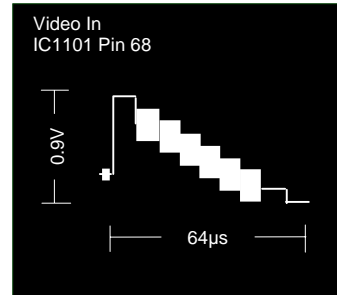
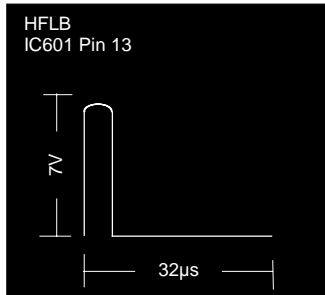
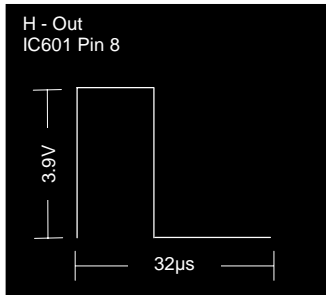
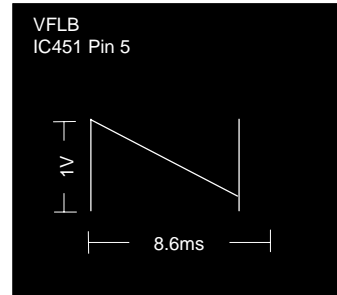
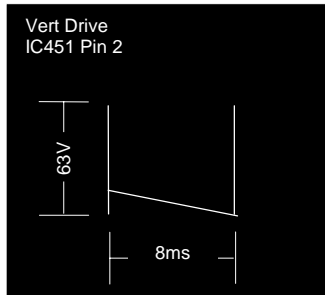
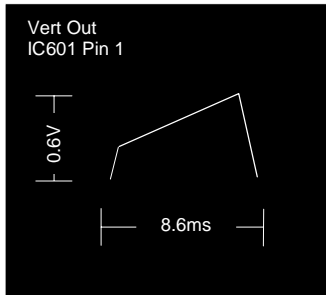

Valori di allineamento, esempi:

(N.B. I valori indicati sullo schermo sono approssimative.)

1. Regolare i toni bassi nella massima posizione, regolare i toni alti nella minima posizione, premere il tasto volume meno sulla tastiera del TV, e nello stesso tempo premere il tasto **"INDEX"** sul telecomando.
2. Premere i tasti **ROSSO** o **VERDE** per selezionare le Funzioni.
3. Premere i tasti **GIALLO** o **BLU** per modificare i valori.
4. Premere il tasto **"STR"** sulla tastiera del TV per memorizzare la regolazione eseguita.
5. Per uscire dal service mode occorre premere il tasto **"N"** sul telecomando.

Funzione	Valori indicativi	Impostazioni
Posizione orizz	H-Pos +020	Posizione ottimale.
V-Pos	V-Pos +024	Posizione ottimale.
Ampiezza orizz	H-Amp +049	Posizione ottimale.
Ampiezza vert	V-Amp +029	Posizione ottimale.
EO-ampiezza	EW-Amp 1 +022	Posizione ottimale.
EO-ampiezza	EW-Amp 2 +000	Posizione ottimale.
Correz-trapezoidale	Trapez-1 +033	Posizione ottimale.
Orizz-Parallel	H-Parallel +032	Posizione ottimale.
Linearita vert	V-Lin +004	Posizione ottimale.
DVCO	DVCO 000	Premere il tasto blu , poi STR .
Cutoff DC	Cut-off O.K.	Per regolare il cutoff collegare la sonda sul blu, e regolare con il tasto giallo o blu per 160V, premere STR . Selezionare Ug2 e regolare la VR per visualizzare ok.
Highlight	High 0031 0031 0031	Contrast Maximum A.I. Off Posizione ottimale.
Sub-Brightness	Sub-Brightness 000	Posizione ottimale.

SCHEMA A BLOCCHI SEGNALI VIDEO

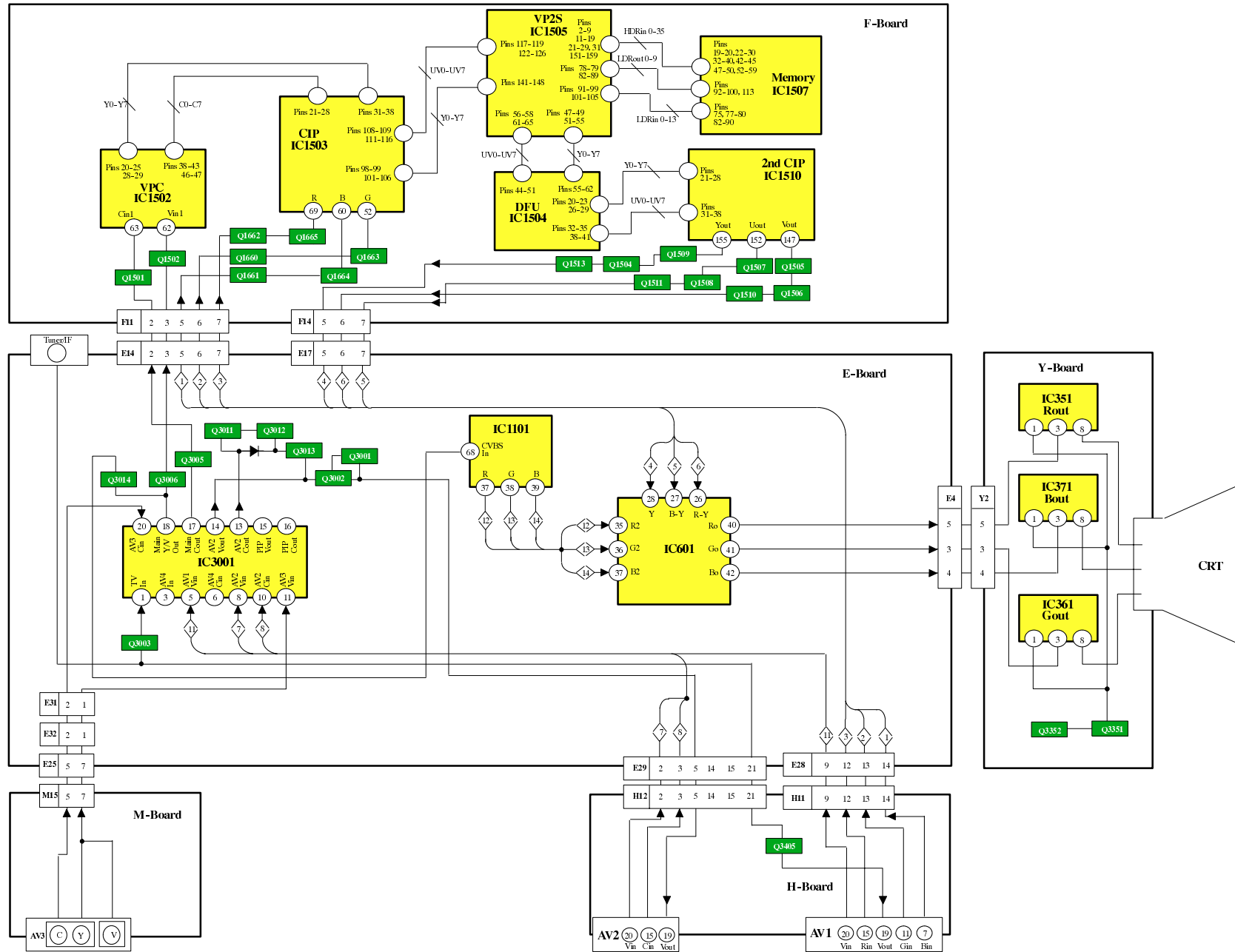

7

SCHEMA A BLOCCHI SEGNALI AUDIO

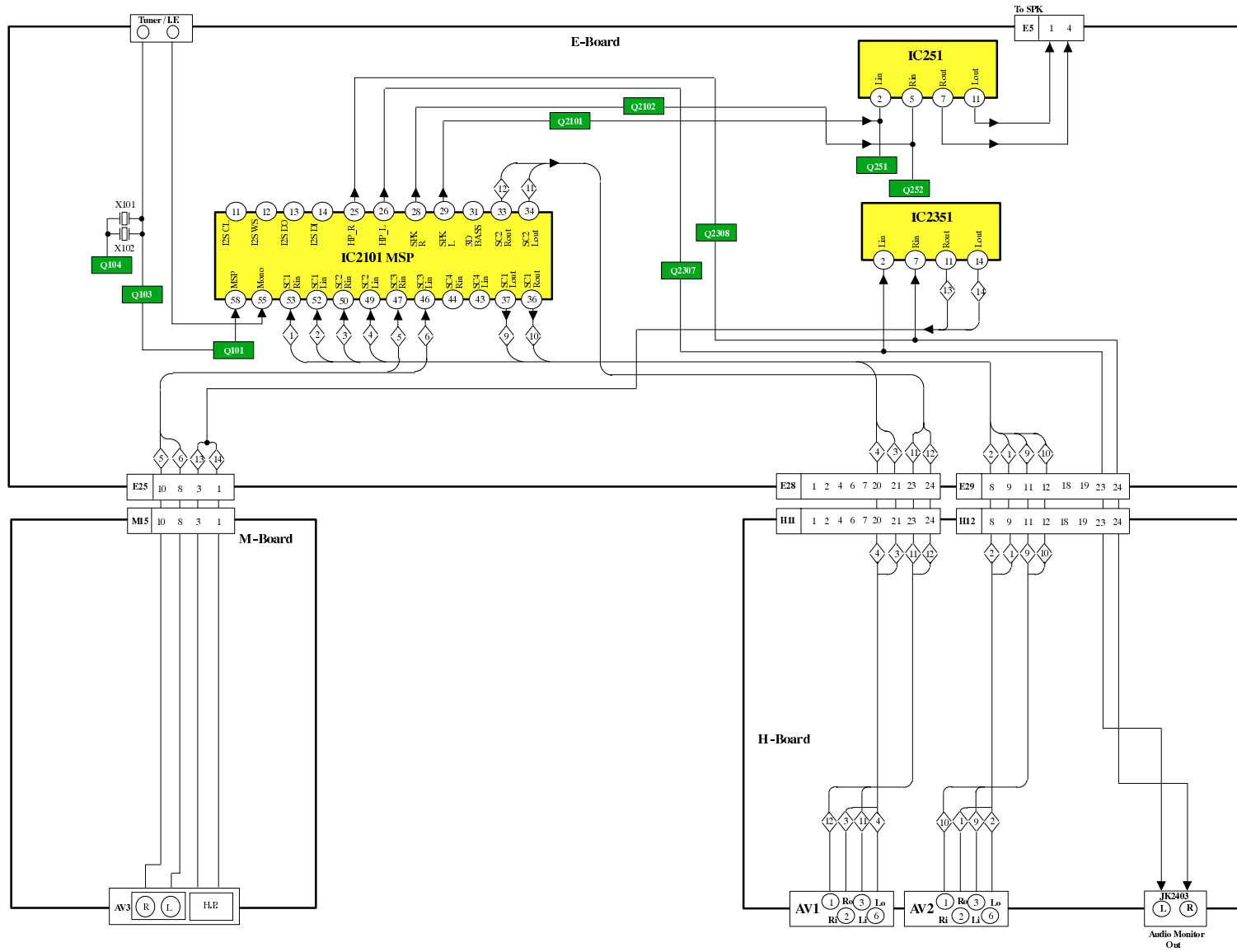

SCHEMA A BLOCCHI LINEE DI CONTROLLO

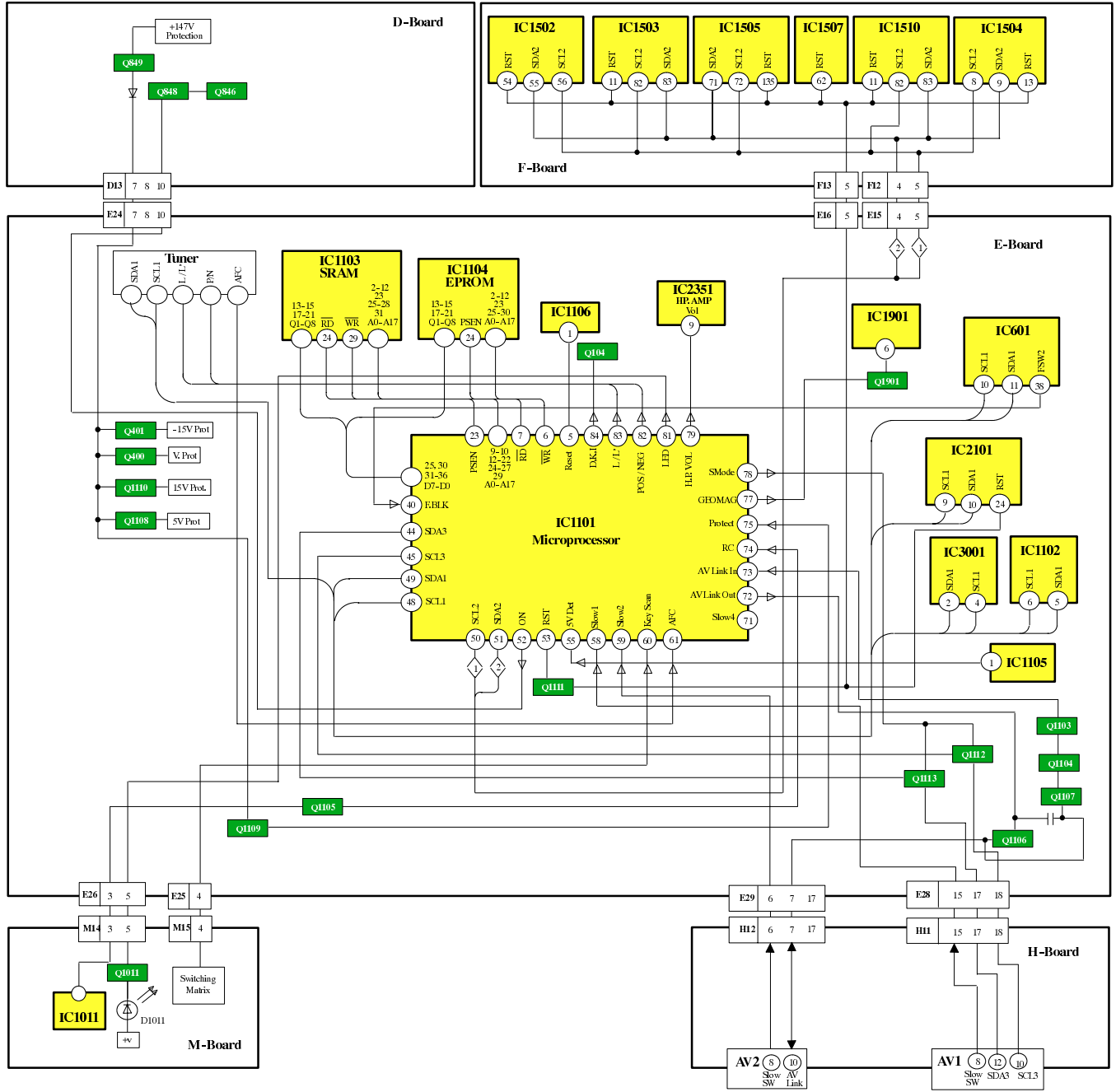

SCHEMA A BLOCCHI POTENZA ALIMENTAZIONE

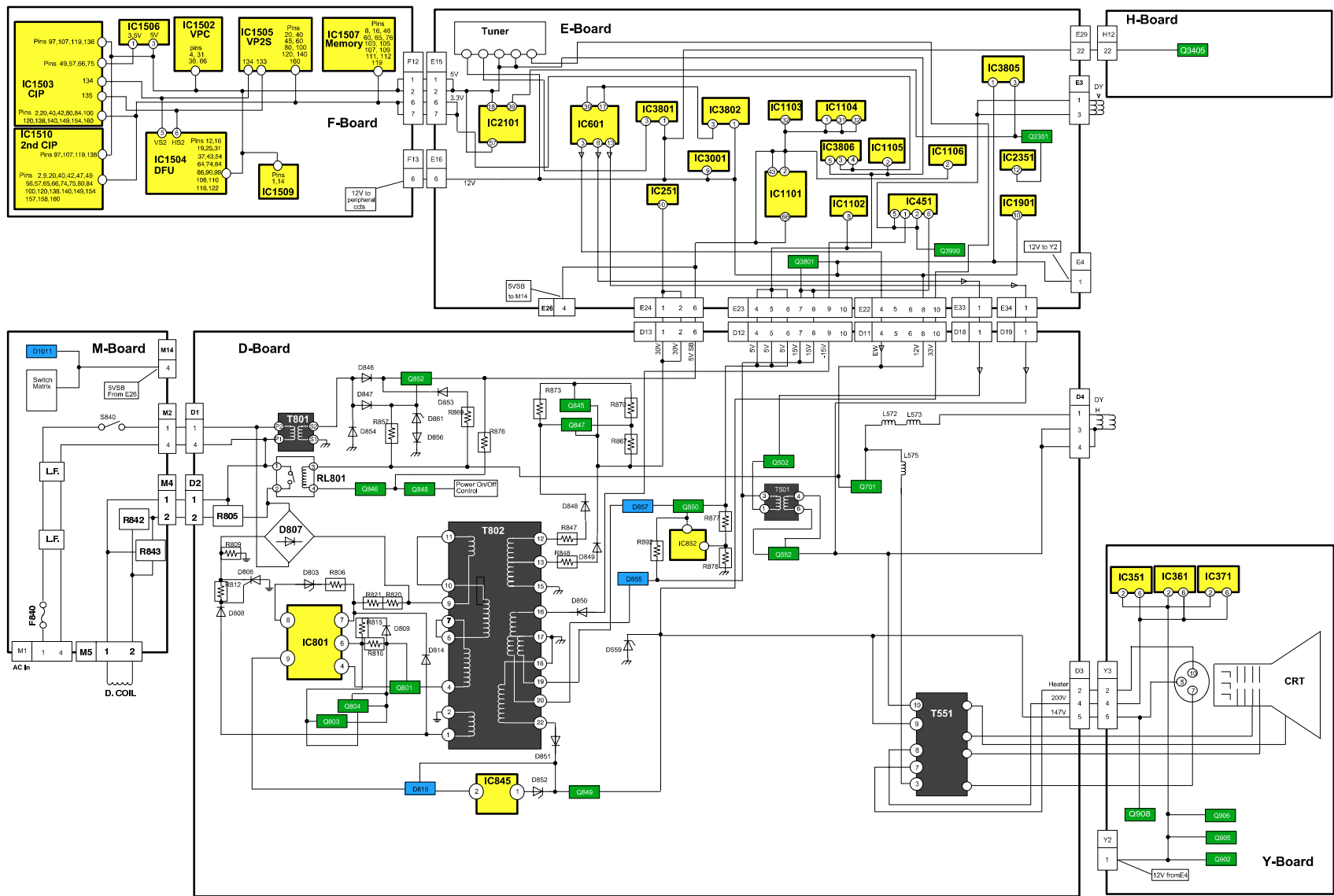

UBICAZIONE DEI COMPONENTI

NOTA:

In questa pagina numeri all' interno di un cerchio corrispondono ai numeri riportanti nell'elenco parti di ricambio.

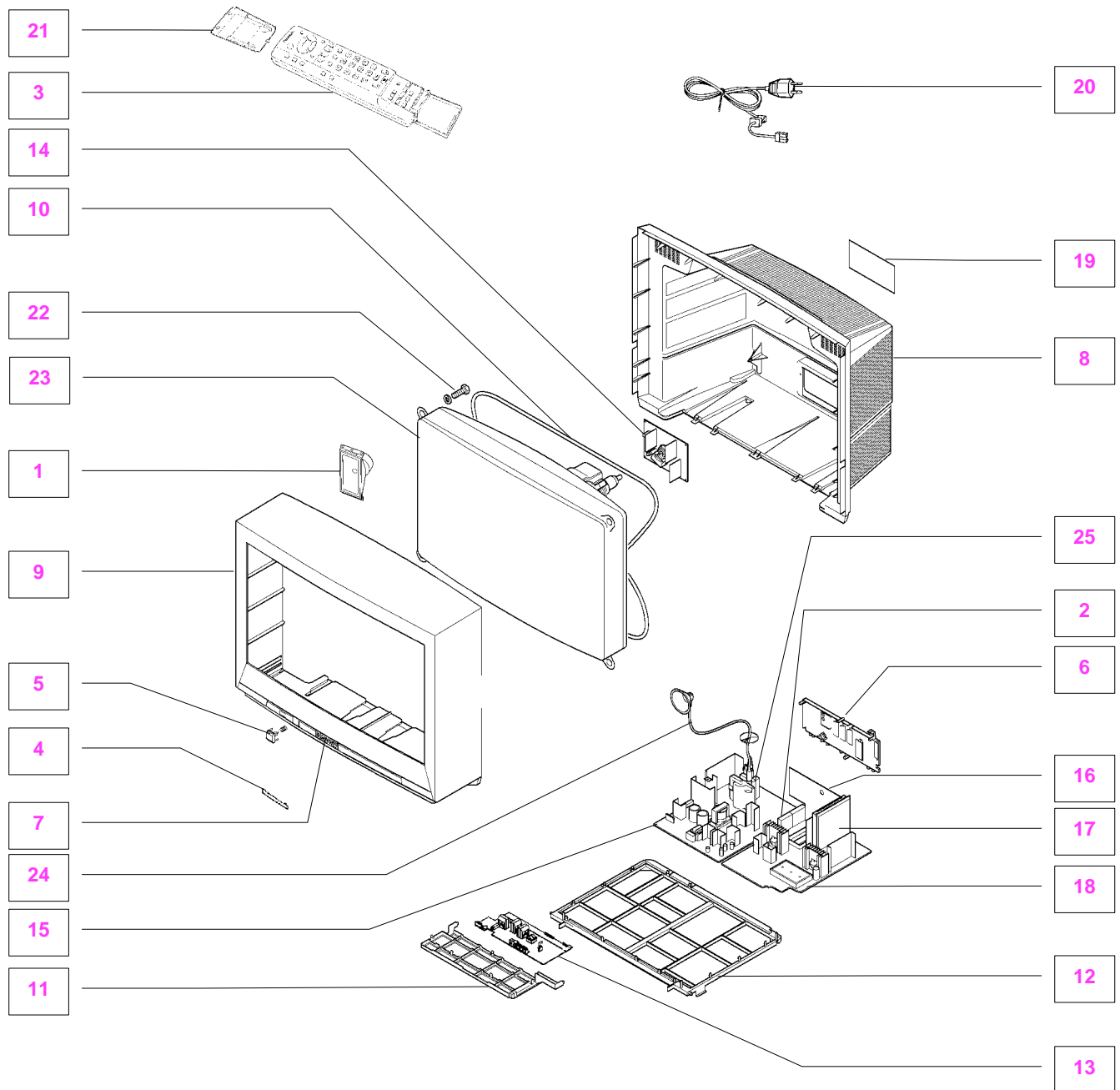

























ELENCO PARTI DI RICAMBIO

Nota

Componenti contrassegnati  sono di sicurezza e devono essere sostituiti solo con quelli specificati.

* Quando ordinate questi ricambi, dovete assolutamente sempre riportare il modello esatto e completo del TV riportato nell'etichetta posteriore del televisore.

Cct Ref	Parts Number	Description
MECHANICAL PARTS		
1	EASG15S506A2	SPEAKER
2	ENG29505GR	TUNER 
3	EUR511211	REMOTE CONTROL
4	TBM8E1928	PANASONIC BADGE
5	TBX8E078	POWER BUTTON
6	TKP8E1253-3	REAR AV PANEL
7	TKP8E1308	DOOR LID
8	TKU8E00540	REAR COVER 
9	TKY8E492-1	CABINET 
10	TLK8E05123	DEGAUSS COIL 
11	TMW8E031	CONTROL BRACKET
12	TMX8E027	CHASSIS FRAME
13	TNP8EM022AA	M P.C.B. 
14	TNP8EY019AA	Y P.C.B. 
15	TNPA1014AU	D P.C.B. 
16	TNPA1047AD	H P.C.B. 
17	TNPA1068AJ	F P.C.B. 
18	TNPH0176BL	E P.C.B. 
19	TQF8E2866	MODEL LABEL 
20	TSX8E0033	POWER CORD 
21	UR51EC904A	BATTERY COVER (REMOTE)
22	VP19151	CRT FIXING SCREW
23	W76ESF031X44	C.R.T. 
24	ZTBZAD550A	ANODE CABLE 
25	ZTFM05001A	F.B.T. 
MISCELLANEOUS COMPONENTS		
	31221212478	FIX CLIP
	832AG11D-ESL	IC SOCKET
	PCSZT-084A-1	IC SOCKET
	TBM8E1901-1	AV LABEL
	TBM8E1976	PRESET LABEL (L)
	TBM8E1977	PRESET LABEL (R)
	TEK6940	LID CATCH
	TES2298	CRT EARTH SPRING
	TES8E019	POWER BUTTON SPRING
	TKP8E1310	IR COVER
	TLK8E05124	GEOMAGNETIC COIL 
	TMW8E030	LED HOLDER
	TMX8E025	P.C.B. BRACKET
	TPC8E4802-1	OUTER CARTON
	TPD8E712	TOP CUSHION
	TPD8E713	BOTTOM CUSHION
	UM-3DJ-2P	BATTERY PACK
	VP19001	C.R.T. BUSH
JK381	0330770054	C.R.T. SOCKET
R805	232266296706	THERMISTOR 
INSTRUCTION BOOKS		
	TQB8E2812A-1	GERMAN 
	TQB8E2812BD1	DUTCH/FRENCH 
	TQB8E2812CE1	ITALIAN/SPANISH 
	TQB8E2812FG1	SWEDISH/NORG. 

Cct Ref	Parts Number	Description
	TQB8E2812HK1	SUOMI/DANISH 
I.C.s		
IC251	LA4282	AUDIO OUTPUT
IC351	TDA6111Q-N4	RGB OUTPUT
IC361	TDA6111Q-N4	RGB OUTPUT
IC371	TDA6111Q-N4	RGB OUTPUT
IC381	TL431CLPM	REGULATOR
IC451	LA7845N	VERTICAL OUTPUT
IC601	TDA9330HN1G	VIDEO PROCESSOR
IC801	AN8029	POWER SUPPLY
IC845	SE140N	ERROR AMPLIFIER
IC852	TL431CLPM	REGULATOR
IC1011	RPM-637CBRL	LED RECEIVER
IC1101	SDA5450C59	MICRO PROCESSOR
IC1102	X24C0502XD	EAROM *
IC1103	KM681000CLP	SRAM
IC1104	27C2001-H14	EPROM *
IC1105	MN1381-R(TA)	RESET
IC1106	MN1381-R(TA)	RESET
IC1502	VPC3215CB8TP	VIDEO PROCESSOR
IC1503	MB87F1720	CIP
IC1504	FJB007S	DFU
IC1505	MB87F2131	VP2S
IC1506	AN77L035M-E1	3.5V REGULATOR
IC1507	MB87H2010	MEMORY
IC1509	TLC2932IPWL	CLOCK CONVERTOR
IC1510	MB87F1720	CIP
IC1901	LA6515	EARTH CORRECTION
IC2101	MSP3410DPPC5	AUDIO PROCESSOR
IC2351	AN7108	H.P. AMPLIFIER
IC3001	TEA6415C	VIDEO SWITCH
IC3801	AN7809FLB	9V REGULATOR
IC3802	AN7708FLB	8V REGULATOR
IC3805	AN7808LB	8V REGULATOR
IC3806	SI-3033C	3.5V REGULATOR
FUSES		
F840	XBA2C50TH15	FUSE 
F845	TR5-T3150	FUSE 
F846	TR5-T1250	FUSE 
F8401	EYF52BC	FUSE HOLDER
F8402	EYF52BC	FUSE HOLDER
DIODES		
D001	MA4020	DIODE
D002	MA4020	DIODE
D252	MA165TA5	DIODE
D253	MA700TA5	DIODE
D254	MA700TA5	DIODE
D255	MA165TA5	DIODE
D351	ERA15-04V3	DIODE
D352	ERA15-04V3	DIODE
D361	ERA15-04V3	DIODE
D362	ERA15-04V3	DIODE

Cct Ref	Parts Number	Description
D371	ERA15-04V3	DIODE
D372	ERA15-04V3	DIODE
D387	MA2160LFS	DIODE
D400	MA4104	DIODE
D401	MA165TA5	DIODE
D402	MA165TA5	DIODE
D404	EU02AV1	DIODE
D405	MA165TA5	DIODE
D408	MA165TA5	DIODE
D502	1SS254T-77	DIODE
D503	EU02	DIODE
D504	EU02	DIODE
D505	ERA81004V3	DIODE
D556	AU02V0	DIODE
D559	MTZJT-7736A	DIODE
D560	1SS252T-77	DIODE
D561	1SS254T-77	DIODE
D563	RH3GLF102	DIODE
D565	MTZJT-7736A	DIODE
D566	MA165TA5	DIODE
D571	FMV-3GULF730	DIODE
D575	1SS252T-77	DIODE
D601	MA29TA5	DIODE
D603	MA4075	DIODE
D605	MA4062	DIODE
D607	MA165TA5	DIODE
D610	MA4043	DIODE
D611	MA165TA5	DIODE
D612	MA165TA5	DIODE
D615	MA165TA5	DIODE
D616	MA178TA5	DIODE
D617	MTZJT-779.1C	DIODE
D618	MTZJT-779.1C	DIODE
D621	MTZJT-778.2A	DIODE
D651	MA165TA5	DIODE
D701	AU02V0	DIODE
D803	MTZJT-7712C	DIODE
D807	RBV-608LF-B	DIODE
D809	1SR124-4AT82	DIODE
D810	MA2180BLFS	DIODE
D812	MTZJT-775.6B	DIODE
D813	MA700TA5	DIODE
D814	AU01ZV0	DIODE
D815	TLP621GR-LF2	PHOTO COUPLER
D818	TMPG10G3	DIODE
D819	ERA81004V3	DIODE
D820	MA4100	DIODE
D821	EU02AV0	DIODE
D845	MA165TA5	DIODE
D846	1SR124-4AT82	DIODE
D847	ERA15-01V3	DIODE
D848	EU02	DIODE
D849	FMGG26S	DIODE
D850	ERB32-02E	DIODE
D851	FMGG2CSLF116	DIODE
D852	MA4062	DIODE
D853	1N4150T-77	DIODE
D854	ERA15-01V3	DIODE
D855	D10SC6MRL	DIODE
D856	MA165TA5	DIODE
D857	FML22SLF610	DIODE
D860	1SS254T-77	DIODE
D861	MTZJT-775.1C	DIODE
D866	MTZJT-7727D	DIODE
D901	1SS254T-77	DIODE
D902	1SS254T-77	DIODE

Cct Ref	Parts Number	Description
D903	1SS254T-77	DIODE
D910	R2KNLFA1	DIODE
D1011	LN81RPHL	DIODE
D1102	MA4051	DIODE
D1103	MA4051	DIODE
D1104	MA165TA5	DIODE
D1105	MA165TA5	DIODE
D1107	MA165TA5	DIODE
D1109	MA165TA5	DIODE
D1110	MA165TA5	DIODE
D1111	MA165TA5	DIODE
D1112	MA165TA5	DIODE
D1501	MA151ATX	DIODE
D2101	MTZJT-7712C	DIODE
D2102	MTZJT-7712C	DIODE
D2351	MTZJT-775.6B	DIODE
D3006	MA4100	DIODE
D3008	MA723TA5	DIODE
D3009	1N4150T-77	DIODE
D3011	MA858TA5	DIODE
D3351	1SS254T-77	DIODE
D3352	MA165TA5	DIODE
D3353	MA165TA5	DIODE
D3354	MA165TA5	DIODE
D3401	MTZJT-7712C	DIODE
D3803	MTZJT-774.7A	DIODE
D3804	MTZJT-778.2A	DIODE
D3805	ERA81004V3	DIODE
D3990	MTZJT-7724D	DIODE
TRANSISTORS		
Q101	BC847B	TRANSISTOR
Q103	BC847B	TRANSISTOR
Q104	BC847B	TRANSISTOR
Q251	2SD1328STX	TRANSISTOR
Q252	2SD1328STX	TRANSISTOR
Q253	BC847B	TRANSISTOR
Q254	BC857B	TRANSISTOR
Q400	BC847B	TRANSISTOR
Q401	BC847B	TRANSISTOR
Q502	2SC2925STA	TRANSISTOR
Q552	2SC5144LB230	TRANSISTOR
Q553	2SC1473-RN	TRANSISTOR
Q554	2SC1473-RN	TRANSISTOR
Q602	BC857B	TRANSISTOR
Q603	BC857B	TRANSISTOR
Q604	BC857B	TRANSISTOR
Q607	BC857B	TRANSISTOR
Q608	BC857B	TRANSISTOR
Q701	2SK2538000LB	TRANSISTOR
Q801	2SK1365LB106	TRANSISTOR
Q803	2SD965-R	TRANSISTOR
Q804	2SA719-TA	TRANSISTOR
Q845	2SA684R	TRANSISTOR
Q846	BC547B/126	TRANSISTOR
Q847	BC557B/126	TRANSISTOR
Q848	BC547B/126	TRANSISTOR
Q849	2SA1018QTA	TRANSISTOR
Q850	2SD1474PLB	TRANSISTOR
Q852	2SC1318-S	TRANSISTOR
Q853	BC557C/126	TRANSISTOR
Q854	BC557C/126	TRANSISTOR
Q902	BC847B	TRANSISTOR
Q903	BC847B	TRANSISTOR
Q904	BC857B	TRANSISTOR
Q905	BC847B	TRANSISTOR
Q906	BC847B	TRANSISTOR

Cct Ref	Parts Number	Description
Q907	BC857B	TRANSISTOR
Q908	2SA1535ARLB	TRANSISTOR
Q909	2SC3944ARLB	TRANSISTOR
Q1011	BC557B/126	TRANSISTOR
Q1103	BC847B	TRANSISTOR
Q1104	BC847B	TRANSISTOR
Q1105	BC847B	TRANSISTOR
Q1106	BC847B	TRANSISTOR
Q1107	BC847B	TRANSISTOR
Q1108	BC847B	TRANSISTOR
Q1109	BC847B	TRANSISTOR
Q1110	BC847B	TRANSISTOR
Q1111	BC847B	TRANSISTOR
Q1112	BC847B	TRANSISTOR
Q1113	BC847B	TRANSISTOR
Q1116	BC847B	TRANSISTOR
Q1118	BC857B	TRANSISTOR
Q1501	BC857B	TRANSISTOR
Q1502	BC857B	TRANSISTOR
Q1503	BC847B	TRANSISTOR
Q1504	BC847B	TRANSISTOR
Q1505	BC847B	TRANSISTOR
Q1506	BC847B	TRANSISTOR
Q1507	BC847B	TRANSISTOR
Q1508	BC847B	TRANSISTOR
Q1509	BC847B	TRANSISTOR
Q1510	BC847B	TRANSISTOR
Q1511	BC847B	TRANSISTOR
Q1513	BC857B	TRANSISTOR
Q1660	BC847B	TRANSISTOR
Q1661	BC847B	TRANSISTOR
Q1662	BC847B	TRANSISTOR
Q1663	BC847B	TRANSISTOR
Q1664	BC847B	TRANSISTOR
Q1665	BC847B	TRANSISTOR
Q1666	BC847B	TRANSISTOR
Q1667	BC847B	TRANSISTOR
Q1901	BC847B	TRANSISTOR
Q2101	BC860B	TRANSISTOR
Q2102	BC860B	TRANSISTOR
Q2301	BC847B	TRANSISTOR
Q2302	BC847B	TRANSISTOR
Q2305	BC857B	TRANSISTOR
Q2307	BC860B	TRANSISTOR
Q2308	BC860B	TRANSISTOR
Q2351	BC847B	TRANSISTOR
Q2352	BC847B	TRANSISTOR
Q3001	BC857B	TRANSISTOR
Q3002	BC847B	TRANSISTOR
Q3003	BC847B	TRANSISTOR
Q3005	BC847B	TRANSISTOR
Q3006	BC847B	TRANSISTOR
Q3010	BC857B	TRANSISTOR
Q3011	BC857B	TRANSISTOR
Q3012	BC847B	TRANSISTOR
Q3013	BC847B	TRANSISTOR
Q3014	BC847B	TRANSISTOR
Q3351	BC847B	TRANSISTOR
Q3352	BC857B	TRANSISTOR
Q3401	BC847B	TRANSISTOR
Q3402	BC847B	TRANSISTOR
Q3403	BC847B	TRANSISTOR
Q3404	BC847B	TRANSISTOR
Q3405	BC847B	TRANSISTOR
Q3801	2SD1474PLB	TRANSISTOR
Q3990	BC847B	TRANSISTOR

Cct Ref	Parts Number	Description
TRANSFORMERS		
T501	ETH19Y187AY	TRANSFORMER
T801	ETP35KAN619U	TRANSFORMER
T802	ETS49AH1W7AD	TRANSFORMER
COILS		
L002	EXCELD35V	COIL
L003	EXCELD35V	COIL
L004	EXCELSA35T	COIL
L005	TLT100K991R	COIL
L007	EXCELD35V	COIL
L008	ELJFC2R2KF	COIL
L009	ELJFC2R2KF	COIL
L251	EXCELSA35T	COIL
L252	EXCELSA35T	COIL
L253	EXCELSA35T	COIL
L254	EXCELSA35T	COIL
L351	ELB4C066B	DELAY LINE
L353	TLT150K991R	COIL
L361	ELB4C066B	DELAY LINE
L363	TLT100K991R	COIL
L371	ELB4C066B	DELAY LINE
L373	TLT150K991R	COIL
L381	TLT220K991R	COIL
L501	ELELN101KA	COIL
L554	EXCELD35V	COIL
L556	EXCELD35C	COIL
L572	ELHKL025B	COIL
L573	ELHKL058B	COIL
L575	ELC18B221L	COIL
L601	EXCELD35V	COIL
L602	EXCELD35V	COIL
L603	TLT033K991R	COIL
L604	ELEXT2R7KA	COIL
L605	ELEXT2R7KA	COIL
L606	ELEXT2R7KA	COIL
L607	ELEXT2R7KA	COIL
L701	ELC18B801L	COIL
L809	EXCELD35C	COIL
L810	EXCELSA39V	COIL
L811	EXCELSA39V	COIL
L812	EXCELD35V	COIL
L813	EXCELD35V	COIL
L817	EXCELD35V	COIL
L819	EXCELSA39V	COIL
L845	EXCELSA35T	COIL
L847	EXCELSA35B	COIL
L849	EXCELSA35T	COIL
L854	ELEIE150KA	COIL
L859	EXCELSA35T	COIL
L860	EXCELSA35T	COIL
L861	EXCELSA35T	COIL
L910	EXCELSA35T	COIL
L911	EXCELSA35T	COIL
L912	EXCELSA35T	COIL
L1101	EXCELD35V	COIL
L1103	TLT047K991R	COIL
L1104	EXCELD35V	COIL
L1105	EXCELD35V	COIL
L1106	TLT047K991R	COIL
L1507	TLT018K991R	COIL
L1508	TLT033K991R	COIL
L1509	EXCELD35V	COIL
L1510	EXCELD35V	COIL
L1511	TLT018K991R	COIL
L1516	EXCELD35V	COIL
L1519	EXCEMT103DTM	COIL

Cct Ref	Parts Number	Description
L1523	EXCEMT103DTM	COIL
L1525	EXCEMT103DTM	COIL
L1527	EXCEMT103DTM	COIL
L1528	EXCELDR35V	COIL
L1529	EXCELDR35V	COIL
L1532	EXCELDR35V	COIL
L1533	EXCELDR35V	COIL
L1534	EXCELDR35V	COIL
L1535	EXCELDR35V	COIL
L1536	EXCELDR35V	COIL
L1537	TLT100K991R	COIL
L1538	TLT018K991R	COIL
L1539	TLT033K991R	COIL
L1540	TLT018K991R	COIL
L1541	TLT033K991R	COIL
L1542	TLT018K991R	COIL
L1543	TLT033K991R	COIL
L1901	EXCELDR25V	COIL
L2101	TLT100K991R	COIL
L2102	TLT039K991R	COIL
L2103	TLT100K991R	COIL
L2104	EXCELDR35V	COIL
L2106	TLT068K991R	COIL
L2381	EXCELSA35T	COIL
L2382	EXCELSA35T	COIL
L2412	EXCELSA35T	COIL
L2413	EXCELSA35T	COIL
L3001	TLT100K991R	COIL
L3205	EXCELDR35V	COIL
L3281	EXCELSA35T	COIL
L3282	EXCELSA35T	COIL
L3283	EXCELSA35T	COIL
L3401	TLT015K991R	COIL
L3402	TLT015K991R	COIL
L3403	TLT015K991R	COIL
L3404	TLT015K991R	COIL
L3405	TLT015K991R	COIL
L3406	TLT015K991R	COIL
L3407	TLT015K991R	COIL
L3408	TLT015K991R	COIL
L3409	TLT100K991R	COIL
L3801	EXCELDR35V	COIL
FILTERS		
L840	ELF18N012A	LINE FILTER
L841	ELF18N012A	LINE FILTER
X101	EFCT6504BF	FILTER
X102	EFCT7004BF	CERAMIC FILTER
CRYSTALS		
X601	TSSA010	CRYSTAL
X1101	TSSA121	CRYSTAL
X1501	TSS2169-B	CRYSTAL
X2101	4730007158	CRYSTAL
RESISTORS		
JSE045	ERDS1TJ2R2	CARBON 0.5W 5% 2R2 Ω
JSE011	ERJ6GEY0R00	S.M.CARB 0.1W 5% 0 Ω
JA41	ERJ6GEY0R00	S.M.CARB 0.1W 5% 0 Ω
JA42	ERJ6GEY0R00	S.M.CARB 0.1W 5% 0 Ω
JA9	ERJ6GEY0R00	S.M.CARB 0.1W 5% 0 Ω
JSE004	ERJ6GEY0R00	S.M.CARB 0.1W 5% 0 Ω
JSE009	ERJ6GEY0R00	S.M.CARB 0.1W 5% 0 Ω
JSE025	ERJ6GEY0R00	S.M.CARB 0.1W 5% 0 Ω
JSE026	ERJ6GEY0R00	S.M.CARB 0.1W 5% 0 Ω
JSE044	ERJ6GEY0R00	S.M.CARB 0.1W 5% 0 Ω
JA40	ERJ6GEY0R00	S.M.CARB 0.1W 5% 0 Ω
JSF001	ERJ6GEY0R00	S.M.CARB 0.1W 5% 0 Ω

Cct Ref	Parts Number	Description
JA3	ERJ6GEY0R00	S.M.CARB 0.1W 5% 0 Ω
JSE055	ERJ6GEY0R00	S.M.CARB 0.1W 5% 0 Ω
JA4	ERJ6GEY0R00	S.M.CARB 0.1W 5% 0 Ω
JA37	ERJ6GEY0R00	S.M.CARB 0.1W 5% 0 Ω
JA36	ERJ6GEY0R00	S.M.CARB 0.1W 5% 0 Ω
JA33	ERJ6GEY0R00	S.M.CARB 0.1W 5% 0 Ω
JSF005	ERJ6GEY0R00	S.M.CARB 0.1W 5% 0 Ω
JA30	ERJ6GEY0R00	S.M.CARB 0.1W 5% 0 Ω
JSF015	ERJ6GEY0R00	S.M.CARB 0.1W 5% 0 Ω
JA29	ERJ6GEY0R00	S.M.CARB 0.1W 5% 0 Ω
JA27	ERJ6GEY0R00	S.M.CARB 0.1W 5% 0 Ω
JA26	ERJ6GEY0R00	S.M.CARB 0.1W 5% 0 Ω
JA24	ERJ6GEY0R00	S.M.CARB 0.1W 5% 0 Ω
JA23	ERJ6GEY0R00	S.M.CARB 0.1W 5% 0 Ω
JA21	ERJ6GEY0R00	S.M.CARB 0.1W 5% 0 Ω
JA2	ERJ6GEY0R00	S.M.CARB 0.1W 5% 0 Ω
JA31	ERJ6GEY0R00	S.M.CARB 0.1W 5% 0 Ω
JSF026	ERJ6GEY0R00	S.M.CARB 0.1W 5% 0 Ω
JSY04	ERJ6GEY0R00	S.M.CARB 0.1W 5% 0 Ω
JSY03	ERJ6GEY0R00	S.M.CARB 0.1W 5% 0 Ω
JSH010	ERJ6GEY0R00	S.M.CARB 0.1W 5% 0 Ω
JSH002	ERJ6GEY0R00	S.M.CARB 0.1W 5% 0 Ω
JSF043	ERJ6GEY0R00	S.M.CARB 0.1W 5% 0 Ω
JSF042	ERJ6GEY0R00	S.M.CARB 0.1W 5% 0 Ω
JSF041	ERJ6GEY0R00	S.M.CARB 0.1W 5% 0 Ω
JSF039	ERJ6GEY0R00	S.M.CARB 0.1W 5% 0 Ω
JSF037	ERJ6GEY0R00	S.M.CARB 0.1W 5% 0 Ω
JSF034	ERJ6GEY0R00	S.M.CARB 0.1W 5% 0 Ω
JSF032	ERJ6GEY0R00	S.M.CARB 0.1W 5% 0 Ω
JSF029	ERJ6GEY0R00	S.M.CARB 0.1W 5% 0 Ω
JSF010	ERJ6GEY0R00	S.M.CARB 0.1W 5% 0 Ω
JSF027	ERJ6GEY0R00	S.M.CARB 0.1W 5% 0 Ω
JSF006	ERJ6GEY0R00	S.M.CARB 0.1W 5% 0 Ω
JSF025	ERJ6GEY0R00	S.M.CARB 0.1W 5% 0 Ω
JSF024	ERJ6GEY0R00	S.M.CARB 0.1W 5% 0 Ω
JSF023	ERJ6GEY0R00	S.M.CARB 0.1W 5% 0 Ω
JSF022	ERJ6GEY0R00	S.M.CARB 0.1W 5% 0 Ω
JSF021	ERJ6GEY0R00	S.M.CARB 0.1W 5% 0 Ω
JSF020	ERJ6GEY0R00	S.M.CARB 0.1W 5% 0 Ω
JSF018	ERJ6GEY0R00	S.M.CARB 0.1W 5% 0 Ω
JSF017	ERJ6GEY0R00	S.M.CARB 0.1W 5% 0 Ω
JSF013	ERJ6GEY0R00	S.M.CARB 0.1W 5% 0 Ω
JA19	ERJ6GEY0R00	S.M.CARB 0.1W 5% 0 Ω
JSF009	ERJ6GEY0R00	S.M.CARB 0.1W 5% 0 Ω
JSF007	ERJ6GEY0R00	S.M.CARB 0.1W 5% 0 Ω
JSF028	ERJ6GEY0R00	S.M.CARB 0.1W 5% 0 Ω
JA18	ERJ6GEY0R00	S.M.CARB 0.1W 5% 0 Ω
JSF019	ERJ6GEY0R00	S.M.CARB 0.1W 5% 0 Ω
JA12	ERJ6GEY0R00	S.M.CARB 0.1W 5% 0 Ω
JA11	ERJ6GEY0R00	S.M.CARB 0.1W 5% 0 Ω
JA1	ERJ6GEY0R00	S.M.CARB 0.1W 5% 0 Ω
JA5	ERJ8GEY0R00	S.M.CARB .125W 5% 0 Ω
JA8	ERJ8GEY0R00	S.M.CARB .125W 5% 0 Ω
JA7	ERJ8GEY0R00	S.M.CARB .125W 5% 0 Ω
JA6	ERJ8GEY0R00	S.M.CARB .125W 5% 0 Ω
JA4	ERJ8GEY0R00	S.M.CARB .125W 5% 0 Ω
JA39	ERJ8GEY0R00	S.M.CARB .125W 5% 0 Ω
JA38	ERJ8GEY0R00	S.M.CARB .125W 5% 0 Ω
JA35	ERJ8GEY0R00	S.M.CARB .125W 5% 0 Ω
JA16	ERJ8GEY0R00	S.M.CARB .125W 5% 0 Ω
JA3	ERJ8GEY0R00	S.M.CARB .125W 5% 0 Ω
JA2	ERJ8GEY0R00	S.M.CARB .125W 5% 0 Ω
JA20	ERJ8GEY0R00	S.M.CARB .125W 5% 0 Ω
JA1	ERJ8GEY0R00	S.M.CARB .125W 5% 0 Ω
JA13	ERJ8GEY0R00	S.M.CARB .125W 5% 0 Ω
JA14	ERJ8GEY0R00	S.M.CARB .125W 5% 0 Ω

Cct Ref	Parts Number	Description			
JA15	ERJ8GEY0R00	S.M.CARB	.125W	5%	0 Ω
RL801	TSE1885-1	RELAY			Ω
R001	ERJ6GEYJ223	S.M.CARB	0.1W	5%	22K Ω
R002	ERJ6GEYJ101	S.M.CARB	0.1W	5%	100 Ω
R003	ERJ6GEYJ393	S.M.CARB	0.1W	5%	39K Ω
R101	ERJ6GEYJ561	S.M.CARB	0.1W	5%	560 Ω
R102	ERJ6GEYJ101	S.M.CARB	0.1W	5%	100 Ω
R103	ERJ6GEYJ563	S.M.CARB	0.1W	5%	56K Ω
R104	ERJ6GEYJ471	S.M.CARB	0.1W	5%	470 Ω
R105	ERJ6GEYJ332	S.M.CARB	0.1W	5%	3K3 Ω
R106	ERJ6GEYJ821	S.M.CARB	0.1W	5%	820 Ω
R107	ERJ6GEYJ102	S.M.CARB	0.1W	5%	1K Ω
R109	ERJ6GEYJ103	S.M.CARB	0.1W	5%	10K Ω
R110	ERJ6GEYJ222	S.M.CARB	0.1W	5%	2K2 Ω
R111	ERJ6GEYJ331	S.M.CARB	0.1W	5%	330 Ω
R251	ERJ6GEYJ331	S.M.CARB	0.1W	5%	330 Ω
R252	ERJ6GEYJ333	S.M.CARB	0.1W	5%	33K Ω
R253	ERJ6GEYJ103	S.M.CARB	0.1W	5%	10K Ω
R254	ERJ6GEYJ331	S.M.CARB	0.1W	5%	330 Ω
R255	ERJ6GEYJ103	S.M.CARB	0.1W	5%	10K Ω
R256	ERJ6GEYJ681	S.M.CARB	0.1W	5%	680 Ω
R257	ERJ6GEY0R00	S.M.CARB	0.1W	5%	0 Ω
R258	ERJ6GEYJ333	S.M.CARB	0.1W	5%	33K Ω
R259	ERJ6GEY0R00	S.M.CARB	0.1W	5%	0 Ω
R260	ERJ6GEYJ103	S.M.CARB	0.1W	5%	10K Ω
R261	ERJ6GEYJ681	S.M.CARB	0.1W	5%	680 Ω
R262	ERJ6GEYJ103	S.M.CARB	0.1W	5%	10K Ω
R263	ERJ6GEYJ104	S.M.CARB	0.1W	5%	100K Ω
R264	ERJ6GEYJ473	S.M.CARB	0.1W	5%	47K Ω
R265	ERDS1TJ2R2	CARBON	0.5W	5%	2R2 Ω
R266	ERDS1TJ2R2	CARBON	0.5W	5%	2R2 Ω
R269	ERJ6GEYJ273	S.M.CARB	0.1W	5%	27K Ω
R270	ERJ6GEYJ273	S.M.CARB	0.1W	5%	27K Ω
R271	ERJ6GEYJ272	S.M.CARB	0.1W	5%	2K7 Ω
R272	ERJ6GEYJ103	S.M.CARB	0.1W	5%	10K Ω
R273	ERJ6GEYJ331	S.M.CARB	0.1W	5%	330 Ω
R274	ERJ6GEYJ330	S.M.CARB	0.1W	5%	33 Ω
R275	ERJ6GEYJ330	S.M.CARB	0.1W	5%	33 Ω
R350	ERQ12AJ151P	FUSIBLE	0.5W	5%	150 Ω [△]
R351	ERJ6GEYJ911	S.M.CARB	0.1W	5%	910 Ω
R352	ERJ6GEYJ102	S.M.CARB	0.1W	5%	1K Ω
R354	ERO25CKF4122	METAL	0.25W	5%	1K2 Ω [△]
R355	ERG2FG823H	METAL	2W	5%	82K Ω [△]
R356	ERJ6GEYJ181	S.M.CARB	0.1W	5%	180 Ω
R357	ERJ6GEYJ822	S.M.CARB	0.1W	5%	8K2 Ω
R358	ERC12GK821C	SOLID	0.5W	5%	820 Ω
R360	ERO50PKF8251	METAL	0.5W	5%	8M2 Ω [△]
R361	ERJ6GEYJ911	S.M.CARB	0.1W	5%	910 Ω
R362	ERJ6GEYJ102	S.M.CARB	0.1W	5%	1K Ω
R364	ERO25CKF4122	METAL	0.25W	5%	1K2 Ω [△]
R365	ERG2FG823H	METAL	2W	5%	82K Ω [△]
R366	ERJ6GEYJ181	S.M.CARB	0.1W	5%	180 Ω
R367	ERJ6GEYJ822	S.M.CARB	0.1W	5%	8K2 Ω
R368	ERC12GK821C	SOLID	0.5W	5%	820 Ω
R369	ERJ6GEY0R00	S.M.CARB	0.1W	5%	0 Ω
R370	ERQ1CJP1R5	METAL	1W	5%	1R5 Ω [△]
R371	ERJ6GEYJ911	S.M.CARB	0.1W	5%	910 Ω
R372	ERJ6GEYJ102	S.M.CARB	0.1W	5%	1K Ω
R374	ERO25CKF4122	METAL	0.25W	5%	1K2 Ω [△]
R375	ERG2FG823H	METAL	2W	5%	82K Ω [△]
R376	ERJ6GEYJ181	S.M.CARB	0.1W	5%	180 Ω
R377	ERJ6GEYJ822	S.M.CARB	0.1W	5%	8K2 Ω
R378	ERC12GK821C	SOLID	0.5W	5%	820 Ω
R379	ERJ6GEY0R00	S.M.CARB	0.1W	5%	0 Ω
R383	ERJ6GEY0R00	S.M.CARB	0.1W	5%	0 Ω
R391	ERJ6GEYJ821	S.M.CARB	0.1W	5%	820 Ω

Cct Ref	Parts Number	Description			
R392	ERJ6GEYJ821	S.M.CARB	0.1W	5%	820 Ω
R393	ERJ6GEYJ821	S.M.CARB	0.1W	5%	820 Ω
R394	ERJ6ENF7500	S.M.CARB	0.1W	5%	75 Ω
R395	ERJ6ENF5900	S.M.CARB	0.1W	5%	90 Ω
R396	ERJ6ENF7500	S.M.CARB	0.1W	5%	75 Ω
R397	ERJ6ENF5900	S.M.CARB	0.1W	5%	90 Ω
R398	ERJ6ENF7500	S.M.CARB	0.1W	5%	75 Ω
R399	ERJ6ENF5900	S.M.CARB	0.1W	5%	90 Ω
R401	ERJ6GEYJ272	S.M.CARB	0.1W	5%	2K7 Ω
R402	ERJ6GEYJ682	S.M.CARB	0.1W	5%	6K8 Ω
R403	ERJ6GEYJ102	S.M.CARB	0.1W	5%	1K Ω
R404	ERJ6GEYJ103	S.M.CARB	0.1W	5%	10K Ω
R416	ERJ6GEYJ682	S.M.CARB	0.1W	5%	6K8 Ω
R418	ERJ6GEYJ682	S.M.CARB	0.1W	5%	6K8 Ω
R419	ERG3FJ471	METAL	3W	5%	470 Ω [△]
R420	ERJ6GEYJ563	S.M.CARB	0.1W	5%	56K Ω
R421	ERJ6GEYJ224	S.M.CARB	0.1W	5%	220K Ω
R441	ERJ6GEYJ273	S.M.CARB	0.1W	5%	27K Ω
R442	ERJ6GEYJ123	S.M.CARB	0.1W	5%	12K Ω
R451	ERDS1TJ3R3	CARBON	0.5W	5%	3R3 Ω
R452	ERDS1TJ3R3	CARBON	0.5W	5%	3R3 Ω
R453	ERJ6GEYJ393	S.M.CARB	0.1W	5%	39K Ω
R454	ERJ6GEYJ123	S.M.CARB	0.1W	5%	12K Ω
R457	ERJ6GEYJ392	S.M.CARB	0.1W	5%	3K9 Ω
R458	ERJ6GEYJ302	S.M.CARB	0.1W	5%	3K Ω
R470	ERJ6GEYJ562	S.M.CARB	0.1W	5%	5K6 Ω
R471	ERDS1FJ1R0	CARBON	0.5W	5%	1 Ω [△]
R504	ERD25TJ271	CARBON	0.25W	5%	270 Ω
R505	ERDS1TJ100	CARBON	0.5W	5%	10 Ω
R506	ERDS1TJ681	CARBON	0.5W	5%	680 Ω
R507	ERDS1TJ681	CARBON	0.5W	5%	680 Ω
R554	ERX3SJSR22	METAL	3W	5%	R22 Ω [△]
R556	ERDS1TJ273	CARBON	0.5W	5%	27K Ω
R557	ERDS1TJ683	CARBON	0.5W	5%	68K Ω
R558	ERDS1TJ273	CARBON	0.5W	5%	27K Ω
R560	ERD25TJ123	CARBON	0.25W	5%	12K Ω
R561	ERD25TJ333	CARBON	0.25W	5%	33K Ω
R562	ERD25TJ393	CARBON	0.25W	5%	39K Ω
R563	ERD25TJ223	CARBON	0.25W	5%	22K Ω
R564	ERDS1TJ394	CARBON	0.5W	5%	390K Ω
R567	ERG3FJ223	METAL	3W	5%	22K Ω [△]
R569	ERDS1TJ120	CARBON	0.5W	5%	12 Ω
R570	ERD25TJ103	CARBON	0.25W	5%	10K Ω
R572	ERG3FJ821	METAL	3W	5%	820 Ω [△]
R574	ERG3FJ151	METAL	3W	5%	150 Ω [△]
R579	ERD25TJ274	CARBON	0.25W	5%	270K Ω
R580	ERD25TJ563	CARBON	0.25W	5%	56K Ω
R581	ERD25TJ104	CARBON	0.25W	5%	100K Ω
R582	ERD25TJ225	CARBON	0.25W	5%	2M2 Ω
R583	ERD25TJ225	CARBON	0.25W	5%	2M2 Ω
R588	ERD25TJ332	CARBON	0.25W	5%	3K3 Ω
R601	ERJ6GEYJ153	S.M.CARB	0.1W	5%	15K Ω
R613	ERJ6GEYJ101	S.M.CARB	0.1W	5%	100 Ω
R614	ERJ6GEYJ101	S.M.CARB	0.1W	5%	100 Ω
R615	ERJ6GEYJ101	S.M.CARB	0.1W	5%	100 Ω
R616	ERJ6GEYJ100	S.M.CARB	0.1W	5%	10 Ω
R617	ERJ6GEYJ102	S.M.CARB	0.1W	5%	1K Ω
R619	ERJ6GEYJ101	S.M.CARB	0.1W	5%	100 Ω
R620	ERJ6GEYJ101	S.M.CARB	0.1W	5%	100 Ω
R622	ERJ6GEYJ393	S.M.CARB	0.1W	5%	39K Ω
R623	ERJ6GEYJ153	S.M.CARB	0.1W	5%	15K Ω
R626	ERJ6GEYJ331	S.M.CARB	0.1W	5%	330 Ω
R627	ERJ6GEYJ102	S.M.CARB	0.1W	5%	1K Ω
R628	ERJ6GEYJ472	S.M.CARB	0.1W	5%	4K7 Ω
R630	ERJ6GEYJ103	S.M.CARB	0.1W	5%	10K Ω
R631	ERJ6GEYJ105	S.M.CARB	0.1W	5%	1M Ω

Cct Ref	Parts Number	Description				
R632	ERJ6GEYJ223	S.M.CARB	0.1W	5%	22K Ω	
R634	ERJ6GEYJ103	S.M.CARB	0.1W	5%	10K Ω	
R635	ERJ6GEYJ101	S.M.CARB	0.1W	5%	100 Ω	
R636	ERJ6GEYJ101	S.M.CARB	0.1W	5%	100 Ω	
R637	ERJ6GEYJ101	S.M.CARB	0.1W	5%	100 Ω	
R646	ERJ6GEYJ821	S.M.CARB	0.1W	5%	820 Ω	
R647	ERJ6GEYJ101	S.M.CARB	0.1W	5%	100 Ω	
R648	ERJ6GEYJ101	S.M.CARB	0.1W	5%	100 Ω	
R649	ERJ6GEYJ101	S.M.CARB	0.1W	5%	100 Ω	
R650	ERJ6GEYJ101	S.M.CARB	0.1W	5%	100 Ω	
R651	ERJ6GEYJ101	S.M.CARB	0.1W	5%	100 Ω	
R652	ERJ6GEYJ101	S.M.CARB	0.1W	5%	100 Ω	
R653	ERJ6GEYJ101	S.M.CARB	0.1W	5%	100 Ω	
R655	ERJ6GEYJ224	S.M.CARB	0.1W	5%	220K Ω	
R658	ERJ6ENF2212	S.M. CAR	0.1W	5%	220 Ω	
R663	ERJ6GEYJ334	S.M.CARB	0.1W	5%	330K Ω	
R664	ERJ6GEYJ682	S.M.CARB	0.1W	5%	6K8 Ω	
R665	ERJ6GEYJ392	S.M.CARB	0.1W	5%	3K9 Ω	
R666	ERJ6GEYJ222	S.M.CARB	0.1W	5%	2K2 Ω	
R667	ERJ6GEYJ393	S.M.CARB	0.1W	5%	39K Ω	
R674	ERJ6GEYJ273	S.M.CARB	0.1W	5%	27K Ω	
R675	ERJ6GEYJ562	S.M.CARB	0.1W	5%	5K6 Ω	
R676	ERJ6GEYJ103	S.M.CARB	0.1W	5%	10K Ω	
R677	ERJ6GEYJ273	S.M.CARB	0.1W	5%	27K Ω	
R678	ERJ6GEYJ562	S.M.CARB	0.1W	5%	5K6 Ω	
R679	ERJ6GEYJ103	S.M.CARB	0.1W	5%	10K Ω	
R680	ERJ6GEYJ393	S.M.CARB	0.1W	5%	39K Ω	
R681	ERJ6GEYJ103	S.M.CARB	0.1W	5%	10K Ω	
R682	ERJ6GEYJ103	S.M.CARB	0.1W	5%	10K Ω	
R683	ERJ6GEYJ103	S.M.CARB	0.1W	5%	10K Ω	
R684	ERJ6GEYJ101	S.M.CARB	0.1W	5%	100 Ω	
R685	ERJ6GEYJ103	S.M.CARB	0.1W	5%	10K Ω	
R686	ERJ6GEYJ102	S.M.CARB	0.1W	5%	1K Ω	
R688	ERJ6ENF3162	S.M. CAR	0.1W	5%	1K6 Ω	
R701	ERX3FJ2R7H	METAL	3W	5%	2R7 Ω	
R702	ERDS1TJ623	CARBON	0.5W	5%	62K Ω	
R703	ERD25TJ393	CARBON	0.25W	5%	39K Ω	
R704	ERDS1TJ330	CARBON	0.5W	5%	33 Ω	
R806	ERD25TJ101	CARBON	0.25W	5%	100 Ω	
R807	ERD25TJ104	CARBON	0.25W	5%	100K Ω	
R809	ERF10ZK4R7	WOUND	10W	5%	4R7 Ω	△
R810	ERD25TJ223	CARBON	0.25W	5%	22K Ω	
R811	ERD25TJ391	CARBON	0.25W	5%	390 Ω	
R815	ERD25TJ100	CARBON	0.25W	5%	10 Ω	
R816	ERDS1TJ330	CARBON	0.5W	5%	33 Ω	
R818	ERD25TJ511	CARBON	0.25W	5%	510 Ω	
R820	ERG3FJ223	METAL	3W	5%	22K Ω	△
R821	ERG3FJ223	METAL	3W	5%	22K Ω	△
R822	ERD25TJ391	CARBON	0.25W	5%	390 Ω	
R823	ERX12SJR22	METAL	0.5W	5%	R22 Ω	
R824	ERX12SJR22	METAL	0.5W	5%	R22 Ω	
R825	ERX12SJR22	METAL	0.5W	5%	R22 Ω	
R827	ERDS1FJ121	CARBON	0.5W	5%	120 Ω	△
R828	ERD25TJ103	CARBON	0.25W	5%	10K Ω	
R829	ERD25TJ221	CARBON	0.25W	5%	220 Ω	
R830	ERX12SJR22	METAL	0.5W	5%	R22 Ω	
R831	ERD75TAJ825	CARBON	0.75W	5%	8M2 Ω	△
R835	ERD25TJ220	CARBON	0.25W	5%	22 Ω	
R836	ERD25TJ100	CARBON	0.25W	5%	10 Ω	
R837	ERD25TJ183	CARBON	0.25W	5%	18K Ω	
R838	ERD25TJ821	CARBON	0.25W	5%	820 Ω	
R841	ERC12ZGK105D	SOLID	0.5W	10%	1M Ω	
R857	ERD25TJ221	CARBON	0.25W	5%	220 Ω	
R862	ERD25TJ272	CARBON	0.25W	5%	2K7 Ω	
R863	ERG3FJ680H	METAL	3W	5%	68 Ω	△
R864	ERDS1TJ682	CARBON	0.5W	5%	6K8 Ω	

Cct Ref	Parts Number	Description				
R867	ERD25TJ102	CARBON	0.25W	5%	1K Ω	
R868	ERD25TJ151	CARBON	0.25W	5%	150 Ω	
R869	ERD25TJ560	CARBON	0.25W	5%	56 Ω	
R870	ERD25TJ101	CARBON	0.25W	5%	100 Ω	
R873	ERQ2CJP2R4	METAL	2W	5%	2R4 Ω	△
R876	ERD25TJ562	CARBON	0.25W	5%	5K6 Ω	
R877	ERO25CKF1022	METAL	0.25W	1%	10K2 Ω	△
R878	ERO25CKF1002	METAL	0.25W	1%	10K Ω	△
R883	ERD25TJ103	CARBON	0.25W	5%	10K Ω	
R885	ERD25TJ103	CARBON	0.25W	5%	10K Ω	
R886	ERX3SJR56	METAL	3W	5%	R56 Ω	
R888	ERDS1TJ393	CARBON	0.5W	5%	39K Ω	
R889	ERD25TJ392	CARBON	0.25W	5%	3K9 Ω	
R891	ERD25TJ103	CARBON	0.25W	5%	10K Ω	
R892	ERD25TJ222	CARBON	0.25W	5%	2K2 Ω	
R897	ERD25TJ183	CARBON	0.25W	5%	18K Ω	
R901	ERJ6GEYJ562	S.M.CARB	0.1W	5%	5K6 Ω	
R902	ERJ6GEYJ562	S.M.CARB	0.1W	5%	5K6 Ω	
R903	ERJ6GEYJ562	S.M.CARB	0.1W	5%	5K6 Ω	
R904	ERJ6GEYJ102	S.M.CARB	0.1W	5%	1K Ω	
R906	ERJ6GEYJ153	S.M.CARB	0.1W	5%	15K Ω	
R907	ERJ6GEYJ222	S.M.CARB	0.1W	5%	2K2 Ω	
R908	ERJ6GEYJ471	S.M.CARB	0.1W	5%	470 Ω	
R909	ERJ6GEYJ222	S.M.CARB	0.1W	5%	2K2 Ω	
R910	ERJ6GEYJ101	S.M.CARB	0.1W	5%	100 Ω	
R911	ERD25TJ561	CARBON	0.25W	5%	560 Ω	
R913	ERJ6GEYJ183	S.M.CARB	0.1W	5%	18K Ω	
R914	ERJ6GEYJ202	S.M.CARB	0.1W	5%	2K Ω	
R915	ERJ6GEYJ182	S.M.CARB	0.1W	5%	1K8 Ω	
R916	ERJ6GEYJ221	S.M.CARB	0.1W	5%	220 Ω	
R919	ERQ14AJW390	FUSIBLE	0.25W	5%	39 Ω	△
R920	ERQ14AJW390	FUSIBLE	0.25W	5%	39 Ω	△
R922	ERD25TJ683	CARBON	0.25W	5%	68K Ω	
R923	ERD25TJ683	CARBON	0.25W	5%	68K Ω	
R924	ERDS1FYJ330	CARBON	0.5W	5%	33 Ω	△
R925	ERJ6GEY0R00	S.M.CARB	0.1W	5%	0 Ω	
R926	ERJ6GEY0R00	S.M.CARB	0.1W	5%	0 Ω	
R927	ERD25TJ122	CARBON	0.25W	5%	1K2 Ω	
R928	ERD25TJ180	CARBON	0.25W	5%	18 Ω	
R929	ERDS1FVJ471	RESISTOR	0.5W	5%	470 Ω	△
R931	ERDS1FYJ390	CARBON	0.5W	5%	39 Ω	△
R935	ERQ14AJW3R9	FUSIBLE	0.25W	5%	3R9 Ω	△
R936	ERQ1CJP102	FUSIBLE	1W	5%	1K Ω	△
R937	ERQ14AJW100	FUSIBLE	0.25W	5%	10 Ω	△
R938	ERD25TJ122	CARBON	0.25W	5%	1K2 Ω	
R941	ERD25TJ9R1	CARBON	0.25W	5%	9R1 Ω	
R1011	ERD25TJ101	CARBON	0.25W	5%	100 Ω	
R1012	ERD25TJ101	CARBON	0.25W	5%	100 Ω	
R1013	ERD25TJ471	CARBON	0.25W	5%	470 Ω	
R1015	ERD25TJ103	CARBON	0.25W	5%	10K Ω	
R1071	ERD25TJ103	CARBON	0.25W	5%	10K Ω	
R1072	ERD25TJ222	CARBON	0.25W	5%	2K2 Ω	
R1073	ERD25TJ222	CARBON	0.25W	5%	2K2 Ω	
R1074	ERD25TJ332	CARBON	0.25W	5%	3K3 Ω	
R1075	ERD25TJ512	CARBON	0.25W	5%	5K1 Ω	
R1076	ERD25TJ912	CARBON	0.25W	5%	9K1 Ω	
R1101	ERJ6GEYJ101	S.M.CARB	0.1W	5%	100 Ω	
R1103	ERJ6GEYJ472	S.M.CARB	0.1W	5%	4K7 Ω	
R1104	ERJ6GEYJ101	S.M.CARB	0.1W	5%	100 Ω	
R1105	ERJ6GEYJ101	S.M.CARB	0.1W	5%	100 Ω	
R1106	ERJ6GEYJ472	S.M.CARB	0.1W	5%	4K7 Ω	
R1107	ERJ6GEYJ101	S.M.CARB	0.1W	5%	100 Ω	
R1108	ERJ6GEYJ472	S.M.CARB	0.1W	5%	4K7 Ω	
R1109	ERJ6GEYJ101	S.M.CARB	0.1W	5%	100 Ω	
R1110	ERJ6GEYJ101	S.M.CARB	0.1W	5%	100 Ω	
R1111	ERJ6GEYJ101	S.M.CARB	0.1W	5%	100 Ω	

Cct Ref	Parts Number	Description			
R1112	ERJ6GEYJ103	S.M.CARB	0.1W	5%	10K Ω
R1113	ERJ6GEYJ101	S.M.CARB	0.1W	5%	100 Ω
R1114	ERJ6GEYJ101	S.M.CARB	0.1W	5%	100 Ω
R1116	ERJ6GEYJ101	S.M.CARB	0.1W	5%	100 Ω
R1117	ERJ6GEYJ332	S.M.CARB	0.1W	5%	3K3 Ω
R1118	ERJ6GEYJ332	S.M.CARB	0.1W	5%	3K3 Ω
R1119	ERJ6GEYJ332	S.M.CARB	0.1W	5%	3K3 Ω
R1120	ERJ6GEYJ332	S.M.CARB	0.1W	5%	3K3 Ω
R1121	ERJ6GEYJ472	S.M.CARB	0.1W	5%	4K7 Ω
R1122	ERJ6GEYJ472	S.M.CARB	0.1W	5%	4K7 Ω
R1123	ERJ6GEYJ273	S.M.CARB	0.1W	5%	27K Ω
R1124	ERJ6GEYJ101	S.M.CARB	0.1W	5%	100 Ω
R1125	ERJ6GEYJ101	S.M.CARB	0.1W	5%	100 Ω
R1126	ERJ6GEYJ101	S.M.CARB	0.1W	5%	100 Ω
R1127	ERJ6GEYJ101	S.M.CARB	0.1W	5%	100 Ω
R1128	ERJ6GEYJ472	S.M.CARB	0.1W	5%	4K7 Ω
R1129	ERJ6GEYJ472	S.M.CARB	0.1W	5%	4K7 Ω
R1130	ERJ6GEYJ104	S.M.CARB	0.1W	5%	100K Ω
R1131	ERJ6GEYJ101	S.M.CARB	0.1W	5%	100 Ω
R1132	ERJ6GEYJ101	S.M.CARB	0.1W	5%	100 Ω
R1133	ERJ6GEYJ101	S.M.CARB	0.1W	5%	100 Ω
R1134	ERJ6GEYJ101	S.M.CARB	0.1W	5%	100 Ω
R1135	ERJ6GEYJ225	S.M.CARB	0.1W	5%	2M2 Ω
R1138	ERJ6GEYJ272	S.M.CARB	0.1W	5%	2K7 Ω
R1139	ERJ6GEYJ472	S.M.CARB	0.1W	5%	4K7 Ω
R1140	ERJ6GEYJ392	S.M.CARB	0.1W	5%	3K9 Ω
R1141	ERJ6GEYJ103	S.M.CARB	0.1W	5%	10K Ω
R1142	ERJ6GEYJ103	S.M.CARB	0.1W	5%	10K Ω
R1143	ERJ6GEYJ101	S.M.CARB	0.1W	5%	100 Ω
R1144	ERJ6GEYJ473	S.M.CARB	0.1W	5%	47K Ω
R1145	ERJ6GEYJ472	S.M.CARB	0.1W	5%	4K7 Ω
R1146	ERJ6GEYJ101	S.M.CARB	0.1W	5%	100 Ω
R1147	ERJ6GEYJ223	S.M.CARB	0.1W	5%	22K Ω
R1148	ERJ6GEYJ104	S.M.CARB	0.1W	5%	100K Ω
R1149	ERJ6GEYJ104	S.M.CARB	0.1W	5%	100K Ω
R1150	ERJ6GEYJ104	S.M.CARB	0.1W	5%	100K Ω
R1151	ERJ6GEYJ103	S.M.CARB	0.1W	5%	10K Ω
R1152	ERJ6GEYJ224	S.M.CARB	0.1W	5%	220K Ω
R1153	ERJ6GEYJ273	S.M.CARB	0.1W	5%	27K Ω
R1154	ERJ6GEYJ221	S.M.CARB	0.1W	5%	220 Ω
R1155	ERJ6GEYJ105	S.M.CARB	0.1W	5%	1M Ω
R1156	ERJ6GEY0R00	S.M.CARB	0.1W	5%	0 Ω
R1157	ERJ6GEYJ100	S.M.CARB	0.1W	5%	10 Ω
R1158	ERJ6GEYJ472	S.M.CARB	0.1W	5%	4K7 Ω
R1160	ERJ6GEY0R00	S.M.CARB	0.1W	5%	0 Ω
R1161	ERJ6GEYJ392	S.M.CARB	0.1W	5%	3K9 Ω
R1162	ERJ6GEYJ102	S.M.CARB	0.1W	5%	1K Ω
R1163	ERJ6GEYJ103	S.M.CARB	0.1W	5%	10K Ω
R1164	ERJ6GEYJ103	S.M.CARB	0.1W	5%	10K Ω
R1165	ERJ6GEYJ103	S.M.CARB	0.1W	5%	10K Ω
R1166	ERJ6GEYJ683	S.M.CARB	0.1W	5%	68K Ω
R1167	ERJ6GEYJ103	S.M.CARB	0.1W	5%	10K Ω
R1168	ERJ6GEYJ103	S.M.CARB	0.1W	5%	10K Ω
R1169	ERJ6GEYJ103	S.M.CARB	0.1W	5%	10K Ω
R1170	ERJ6GEYJ472	S.M.CARB	0.1W	5%	4K7 Ω
R1171	ERJ6GEYJ472	S.M.CARB	0.1W	5%	4K7 Ω
R1172	ERJ6GEYJ821	S.M.CARB	0.1W	5%	820 Ω
R1173	ERJ6GEYJ681	S.M.CARB	0.1W	5%	680 Ω
R1174	ERJ6GEYJ681	S.M.CARB	0.1W	5%	680 Ω
R1175	ERJ6GEYJ101	S.M.CARB	0.1W	5%	100 Ω
R1176	ERJ6GEYJ101	S.M.CARB	0.1W	5%	100 Ω
R1177	ERJ6GEYJ103	S.M.CARB	0.1W	5%	10K Ω
R1178	ERJ6GEYJ103	S.M.CARB	0.1W	5%	10K Ω
R1179	ERJ6GEYJ101	S.M.CARB	0.1W	5%	100 Ω
R1180	ERJ6GEYJ472	S.M.CARB	0.1W	5%	4K7 Ω
R1181	ERJ6GEYJ101	S.M.CARB	0.1W	5%	100 Ω

Cct Ref	Parts Number	Description			
R1182	ERJ6GEYJ472	S.M.CARB	0.1W	5%	4K7 Ω
R1183	ERJ6GEYJ472	S.M.CARB	0.1W	5%	4K7 Ω
R1184	ERJ6GEYJ101	S.M.CARB	0.1W	5%	100 Ω
R1186	ERJ6GEYJ103	S.M.CARB	0.1W	5%	10K Ω
R1187	ERJ6GEYJ103	S.M.CARB	0.1W	5%	10K Ω
R1188	ERJ6GEYJ472	S.M.CARB	0.1W	5%	4K7 Ω
R1189	ERJ6GEYJ101	S.M.CARB	0.1W	5%	100 Ω
R1190	ERJ6GEYJ472	S.M.CARB	0.1W	5%	4K7 Ω
R1194	ERJ6GEYJ681	S.M.CARB	0.1W	5%	680 Ω
R1195	ERJ6GEYJ103	S.M.CARB	0.1W	5%	10K Ω
R1200	ERJ6GEYJ472	S.M.CARB	0.1W	5%	4K7 Ω
R1237	ERJ6GEYJ121	S.M.CARB	0.1W	5%	120 Ω
R1238	ERJ6GEYJ102	S.M.CARB	0.1W	5%	1K Ω
R1501	ERJ6GEY0R00	S.M.CARB	0.1W	5%	0 Ω
R1502	ERJ6GEYJ151	S.M.CARB	0.1W	5%	150 Ω
R1503	ERJ6GEYJ332	S.M.CARB	0.1W	5%	3K3 Ω
R1504	ERJ6GEYJ151	S.M.CARB	0.1W	5%	150 Ω
R1505	ERJ6GEYJ471	S.M.CARB	0.1W	5%	470 Ω
R1506	ERJ6GEYJ271	S.M.CARB	0.1W	5%	270 Ω
R1507	ERJ6GEYJ102	S.M.CARB	0.1W	5%	1K Ω
R1508	ERJ6GEYJ471	S.M.CARB	0.1W	5%	470 Ω
R1509	ERJ6GEYJ471	S.M.CARB	0.1W	5%	470 Ω
R1510	ERJ6GEYJ8R2	S.M. CAR	0.1W	5%	8R2 Ω
R1511	ERJ6GEYJ101	S.M.CARB	0.1W	5%	100 Ω
R1513	ERJ6GEYJ101	S.M.CARB	0.1W	5%	100 Ω
R1514	ERJ6GEYJ180	S.M.CARB	0.1W	5%	18 Ω
R1515	ERJ6GEYJ101	S.M.CARB	0.1W	5%	100 Ω
R1517	ERJ6GEYJ180	S.M.CARB	0.1W	5%	18 Ω
R1518	ERJ6GEYJ180	S.M.CARB	0.1W	5%	18 Ω
R1519	ERJ6GEYJ561	S.M.CARB	0.1W	5%	560 Ω
R1520	ERJ6GEYJ471	S.M.CARB	0.1W	5%	470 Ω
R1521	ERJ6GEYJ820	S.M.CARB	0.1W	5%	82 Ω
R1522	ERJ6GEYJ302	S.M.CARB	0.1W	5%	3K Ω
R1523	ERJ6GEYJ390	S.M.CARB	0.1W	5%	39 Ω
R1524	ERJ6GEYJ560	S.M.CARB	0.1W	5%	56 Ω
R1525	ERJ6GEYJ271	S.M.CARB	0.1W	5%	270 Ω
R1526	ERJ6GEY0R00	S.M.CARB	0.1W	5%	0 Ω
R1527	ERJ6GEYJ100	S.M.CARB	0.1W	5%	10 Ω
R1528	ERJ6GEYJ151	S.M.CARB	0.1W	5%	150 Ω
R1530	ERJ6GEYJ560	S.M.CARB	0.1W	5%	56 Ω
R1531	ERJ6GEYJ151	S.M.CARB	0.1W	5%	150 Ω
R1532	ERJ6GEYJ151	S.M.CARB	0.1W	5%	150 Ω
R1533	ERJ6GEYJ181	S.M.CARB	0.1W	5%	180 Ω
R1534	ERJ6GEYJ272	S.M.CARB	0.1W	5%	2K7 Ω
R1535	ERJ6GEYJ103	S.M.CARB	0.1W	5%	10K Ω
R1536	ERJ6GEYJ470	S.M.CARB	0.1W	5%	47 Ω
R1537	ERJ6GEYJ103	S.M.CARB	0.1W	5%	10K Ω
R1538	ERJ6GEYJ181	S.M.CARB	0.1W	5%	180 Ω
R1540	ERJ6GEYJ102	S.M.CARB	0.1W	5%	1K Ω
R1541	ERJ6GEYJ102	S.M.CARB	0.1W	5%	1K Ω
R1542	ERJ6GEYJ151	S.M.CARB	0.1W	5%	150 Ω
R1543	ERJ6GEYJ103	S.M.CARB	0.1W	5%	10K Ω
R1544	ERJ6GEYJ561	S.M.CARB	0.1W	5%	560 Ω
R1545	ERJ6ENF3600	S.M. CAR	0.1W	5%	36 Ω
R1546	ERJ6GEYJ561	S.M.CARB	0.1W	5%	560 Ω
R1547	ERJ6GEYJ103	S.M.CARB	0.1W	5%	10K Ω
R1548	ERJ6GEYJ221	S.M.CARB	0.1W	5%	220 Ω
R1550	ERJ6GEYJ103	S.M.CARB	0.1W	5%	10K Ω
R1551	ERJ6GEYJ271	S.M.CARB	0.1W	5%	270 Ω
R1552	ERJ6GEYJ103	S.M.CARB	0.1W	5%	10K Ω
R1553	ERJ6GEYJ750	S.M.CARB	0.1W	5%	75 Ω
R1554	ERJ6GEYJ101	S.M.CARB	0.1W	5%	100 Ω
R1555	ERJ6GEYJ101	S.M.CARB	0.1W	5%	100 Ω
R1556	ERJ6GEYJ101	S.M.CARB	0.1W	5%	100 Ω
R1559	ERJ6ENF2200	S.M. CAR	0.1W	5%	22 Ω
R1560	ERJ6GEYJ560	S.M.CARB	0.1W	5%	56 Ω

Cct Ref	Parts Number	Description			
R1561	ERJ6GEY0R00	S.M.CARB	0.1W	5%	0 Ω
R1562	ERJ6ENF4750	S.M. CAR	0.1W	5%	75 Ω
R1563	ERJ6GEYJ271	S.M.CARB	0.1W	5%	270 Ω
R1564	ERJ6ENF2200	S.M. CAR	0.1W	5%	22 Ω
R1565	ERJ6GEYJ820	S.M.CARB	0.1W	5%	82 Ω
R1566	ERJ6GEYJ331	S.M.CARB	0.1W	5%	330 Ω
R1567	ERJ6ENF1500	S.M. CAR	0.1W	5%	15 Ω
R1568	ERJ6ENF1500	S.M. CAR	0.1W	5%	15 Ω
R1569	ERJ6ENF1500	S.M. CAR	0.1W	5%	15 Ω
R1570	ERJ6ENF2701	S.M.CARB	0.1W	5%	27 Ω
R1571	ERJ6GEYJ103	S.M.CARB	0.1W	5%	10K Ω
R1572	ERJ6GEYJ103	S.M.CARB	0.1W	5%	10K Ω
R1573	ERJ6ENF1500	S.M. CAR	0.1W	5%	15 Ω
R1574	ERJ6GEYJ560	S.M.CARB	0.1W	5%	56 Ω
R1575	ERJ6GEYJ102	S.M.CARB	0.1W	5%	1K Ω
R1576	ERJ6GEYJ102	S.M.CARB	0.1W	5%	1K Ω
R1577	ERJ6GEYJ102	S.M.CARB	0.1W	5%	1K Ω
R1578	ERJ6GEYJ301	S.M.CARB	0.1W	5%	300 Ω
R1579	ERJ6GEYJ431	S.M.CARB	0.1W	5%	430 Ω
R1580	ERJ6GEYJ511	S.M.CARB	0.1W	5%	510 Ω
R1581	ERJ6GEYJ151	S.M.CARB	0.1W	5%	150 Ω
R1582	ERJ6GEYJ103	S.M.CARB	0.1W	5%	10K Ω
R1583	ERJ6GEYJ561	S.M.CARB	0.1W	5%	560 Ω
R1584	ERJ6GEYJ561	S.M.CARB	0.1W	5%	560 Ω
R1585	ERJ6GEYJ103	S.M.CARB	0.1W	5%	10K Ω
R1586	ERJ6GEY0R00	S.M.CARB	0.1W	5%	0 Ω
R1587	ERJ6GEY0R00	S.M.CARB	0.1W	5%	0 Ω
R1588	ERJ6GEYJ221	S.M.CARB	0.1W	5%	220 Ω
R1589	ERJ6GEYJ152	S.M.CARB	0.1W	5%	1K5 Ω
R1590	ERJ6GEYJ101	S.M.CARB	0.1W	5%	100 Ω
R1591	ERJ6GEYJ103	S.M.CARB	0.1W	5%	10K Ω
R1592	ERJ6GEYJ101	S.M.CARB	0.1W	5%	100 Ω
R1593	ERJ6GEYJ101	S.M.CARB	0.1W	5%	100 Ω
R1594	ERJ6GEYJ101	S.M.CARB	0.1W	5%	100 Ω
R1595	ERJ6GEYJ101	S.M.CARB	0.1W	5%	100 Ω
R1598	ERJ6GEYJ101	S.M.CARB	0.1W	5%	100 Ω
R1599	ERJ6GEYJ101	S.M.CARB	0.1W	5%	100 Ω
R1600	ERJ6GEYJ103	S.M.CARB	0.1W	5%	10K Ω
R1603	ERJ6GEYJ101	S.M.CARB	0.1W	5%	100 Ω
R1604	ERJ6GEYJ820	S.M.CARB	0.1W	5%	82 Ω
R1605	ERJ6GEYJ183	S.M.CARB	0.1W	5%	18K Ω
R1606	ERJ6GEYJ273	S.M.CARB	0.1W	5%	27K Ω
R1607	ERJ6GEYJ101	S.M.CARB	0.1W	5%	100 Ω
R1609	ERJ6GEYJ103	S.M.CARB	0.1W	5%	10K Ω
R1610	ERJ6GEYJ101	S.M.CARB	0.1W	5%	100 Ω
R1611	ERJ6GEYJ101	S.M.CARB	0.1W	5%	100 Ω
R1613	ERJ6GEYJ102	S.M.CARB	0.1W	5%	1K Ω
R1614	ERJ6GEY0R00	S.M.CARB	0.1W	5%	0 Ω
R1615	ERJ6GEY0R00	S.M.CARB	0.1W	5%	0 Ω
R1616	ERJ6GEYJ101	S.M.CARB	0.1W	5%	100 Ω
R1617	ERJ6ENF1100	S.M. CAR	0.1W	5%	10 Ω
R1618	ERJ6GEYJ103	S.M.CARB	0.1W	5%	10K Ω
R1619	ERJ6GEYJ103	S.M.CARB	0.1W	5%	10K Ω
R1620	ERJ6GEYJ331	S.M.CARB	0.1W	5%	330 Ω
R1621	ERJ6GEYJ471	S.M.CARB	0.1W	5%	470 Ω
R1622	ERJ6GEYJ102	S.M.CARB	0.1W	5%	1K Ω
R1623	ERJ6GEYJ471	S.M.CARB	0.1W	5%	470 Ω
R1624	ERJ6GEYJ333	S.M.CARB	0.1W	5%	33K Ω
R1625	ERJ6GEYJ221	S.M.CARB	0.1W	5%	220 Ω
R1626	ERJ6GEYJ332	S.M.CARB	0.1W	5%	3K3 Ω
R1627	ERJ6GEYJ100	S.M.CARB	0.1W	5%	10 Ω
R1628	ERJ6GEY0R00	S.M.CARB	0.1W	5%	0 Ω
R1629	ERJ6GEYJ121	S.M.CARB	0.1W	5%	120 Ω
R1630	ERJ6GEYJ103	S.M.CARB	0.1W	5%	10K Ω
R1631	ERJ6ENF1500	S.M. CAR	0.1W	5%	15 Ω
R1632	ERJ6GEY0R00	S.M.CARB	0.1W	5%	0 Ω

Cct Ref	Parts Number	Description			
R1633	ERJ6GEY0R00	S.M.CARB	0.1W	5%	0 Ω
R1634	ERJ6GEYJ101	S.M.CARB	0.1W	5%	100 Ω
R1635	ERJ6GEYJ271	S.M.CARB	0.1W	5%	270 Ω
R1636	ERJ6GEYJ101	S.M.CARB	0.1W	5%	100 Ω
R1637	ERJ6GEYJ271	S.M.CARB	0.1W	5%	270 Ω
R1639	ERJ6GEYJ331	S.M.CARB	0.1W	5%	330 Ω
R1640	ERJ6GEY0R00	S.M.CARB	0.1W	5%	0 Ω
R1641	ERJ6GEYJ473	S.M.CARB	0.1W	5%	47K Ω
R1642	ERJ6GEYJ183	S.M.CARB	0.1W	5%	18K Ω
R1643	ERJ6GEYJ473	S.M.CARB	0.1W	5%	47K Ω
R1644	ERJ6GEYJ183	S.M.CARB	0.1W	5%	18K Ω
R1645	ERJ6GEYJ473	S.M.CARB	0.1W	5%	47K Ω
R1646	ERJ6GEYJ183	S.M.CARB	0.1W	5%	18K Ω
R1660	ERJ6GEYJ103	S.M.CARB	0.1W	5%	10K Ω
R1661	ERJ6GEYJ471	S.M.CARB	0.1W	5%	470 Ω
R1662	ERJ6GEYJ223	S.M.CARB	0.1W	5%	22K Ω
R1663	ERJ6GEYJ331	S.M.CARB	0.1W	5%	330 Ω
R1664	ERJ6GEYJ103	S.M.CARB	0.1W	5%	10K Ω
R1665	ERJ6GEYJ471	S.M.CARB	0.1W	5%	470 Ω
R1666	ERJ6GEYJ223	S.M.CARB	0.1W	5%	22K Ω
R1667	ERJ6GEYJ331	S.M.CARB	0.1W	5%	330 Ω
R1668	ERJ6GEYJ103	S.M.CARB	0.1W	5%	10K Ω
R1669	ERJ6GEYJ471	S.M.CARB	0.1W	5%	470 Ω
R1670	ERJ6GEYJ223	S.M.CARB	0.1W	5%	22K Ω
R1671	ERJ6GEYJ331	S.M.CARB	0.1W	5%	330 Ω
R1672	ERJ6GEYJ471	S.M.CARB	0.1W	5%	470 Ω
R1673	ERJ6GEY0R00	S.M.CARB	0.1W	5%	0 Ω
R1674	ERJ6GEY0R00	S.M.CARB	0.1W	5%	0 Ω
R1675	ERJ6GEY0R00	S.M.CARB	0.1W	5%	0 Ω
R1676	ERJ6GEYJ560	S.M.CARB	0.1W	5%	56 Ω
R1677	ERJ6ENF6800	S.M. CAR	0.1W	5%	80 Ω
R1678	ERJ6ENF1500	S.M. CAR	0.1W	5%	15 Ω
R1679	ERJ6ENF1500	S.M. CAR	0.1W	5%	15 Ω
R1680	ERJ6GEYJ271	S.M.CARB	0.1W	5%	270 Ω
R1681	ERJ6GEYJ271	S.M.CARB	0.1W	5%	270 Ω
R1682	ERJ6GEYJ271	S.M.CARB	0.1W	5%	270 Ω
R1683	ERJ6GEYJ271	S.M.CARB	0.1W	5%	270 Ω
R1684	ERJ6GEYJ271	S.M.CARB	0.1W	5%	270 Ω
R1685	ERQ14AJ100	FUSIBLE	0.25W	5%	10 Ω
R1686	ERJ6GEYJ103	S.M.CARB	0.1W	5%	10K Ω
R1687	ERJ6GEYJ103	S.M.CARB	0.1W	5%	10K Ω
R1688	ERJ6GEYJ331	S.M.CARB	0.1W	5%	330 Ω
R1690	ERJ6ENF75R0	S.M.CARB	0.5W	5%	75 Ω
R1691	ERJ6ENF75R0	S.M.CARB	0.5W	5%	75 Ω
R1692	ERJ6ENF75R0	S.M.CARB	0.5W	5%	75 Ω
R1901	ERDS1TJ100	CARBON	0.5W	5%	10 Ω
R1902	ERDS1TJ100	CARBON	0.5W	5%	10 Ω
R1903	ERJ6GEYJ683	S.M.CARB	0.1W	5%	68K Ω
R1904	ERJ6GEYJ334	S.M.CARB	0.1W	5%	330K Ω
R1905	ERJ6GEYJ683	S.M.CARB	0.1W	5%	68K Ω
R1906	ERJ6GEYJ563	S.M.CARB	0.1W	5%	56K Ω
R1907	ERJ6GEY0R00	S.M.CARB	0.1W	5%	0 Ω
R1908	ERJ6GEYJ472	S.M.CARB	0.1W	5%	4K7 Ω
R1909	ERJ6GEYJ362	S.M. CAR	0.1W	5%	3K6 Ω
R1910	ERJ6GEYJ222	S.M.CARB	0.1W	5%	2K2 Ω
R1911	ERJ6GEY0R00	S.M.CARB	0.1W	5%	0 Ω
R1912	ERJ6GEYJ103	S.M.CARB	0.1W	5%	10K Ω
R1913	ERJ6GEYJ222	S.M.CARB	0.1W	5%	2K2 Ω
R2101	ERJ6GEYJ101	S.M.CARB	0.1W	5%	100 Ω
R2102	ERJ6GEYJ101	S.M.CARB	0.1W	5%	100 Ω
R2103	ERJ6GEY0R00	S.M.CARB	0.1W	5%	0 Ω
R2104	ERJ6GEY0R00	S.M.CARB	0.1W	5%	0 Ω
R2105	ERJ6GEYJ102	S.M.CARB	0.1W	5%	1K Ω
R2106	ERJ6GEYJ101	S.M.CARB	0.1W	5%	100 Ω
R2107	ERJ6GEYJ101	S.M.CARB	0.1W	5%	100 Ω
R2108	ERJ6GEYJ103	S.M.CARB	0.1W	5%	10K Ω

Cct Ref	Parts Number	Description				
R2109	ERJ6GEYJ472	S.M.CARB	0.1W	5%	4K7 Ω	
R2110	ERJ6GEYJ101	S.M.CARB	0.1W	5%	100 Ω	
R2111	ERJ6GEYJ471	S.M.CARB	0.1W	5%	470 Ω	
R2112	ERJ6GEYJ472	S.M.CARB	0.1W	5%	4K7 Ω	
R2114	ERJ6GEYJ101	S.M.CARB	0.1W	5%	100 Ω	
R2117	ERJ6GEYJ222	S.M.CARB	0.1W	5%	2K2 Ω	
R2118	ERJ6GEYJ471	S.M.CARB	0.1W	5%	470 Ω	
R2120	ERJ6GEYJ471	S.M.CARB	0.1W	5%	470 Ω	
R2121	ERJ6GEYJ222	S.M.CARB	0.1W	5%	2K2 Ω	
R2125	ERJ6GEYJ103	S.M.CARB	0.1W	5%	10K Ω	
R2301	ERJ6GEYJ104	S.M.CARB	0.1W	5%	100K Ω	
R2302	ERJ6GEYJ103	S.M.CARB	0.1W	5%	10K Ω	
R2303	ERJ6GEYJ104	S.M.CARB	0.1W	5%	100K Ω	
R2304	ERJ6GEYJ471	S.M.CARB	0.1W	5%	470 Ω	
R2307	ERJ6GEYJ471	S.M.CARB	0.1W	5%	470 Ω	
R2308	ERJ6GEYJ103	S.M.CARB	0.1W	5%	10K Ω	
R2312	ERJ6GEYJ272	S.M.CARB	0.1W	5%	2K7 Ω	
R2314	ERJ6GEYJ471	S.M.CARB	0.1W	5%	470 Ω	
R2315	ERJ6GEYJ471	S.M.CARB	0.1W	5%	470 Ω	
R2316	ERJ6GEYJ222	S.M.CARB	0.1W	5%	2K2 Ω	
R2318	ERJ6GEYJ331	S.M.CARB	0.1W	5%	330 Ω	
R2319	ERJ6GEYJ222	S.M.CARB	0.1W	5%	2K2 Ω	
R2320	ERJ6GEYJ101	S.M.CARB	0.1W	5%	100 Ω	
R2321	ERJ6GEYJ101	S.M.CARB	0.1W	5%	100 Ω	
R2351	ERJ6GEYJ102	S.M.CARB	0.1W	5%	1K Ω	
R2352	ERJ6GEYJ102	S.M.CARB	0.1W	5%	1K Ω	
R2353	ERJ6GEYJ103	S.M.CARB	0.1W	5%	10K Ω	
R2354	ERJ6GEYJ103	S.M.CARB	0.1W	5%	10K Ω	
R2355	ERJ6GEYJ103	S.M.CARB	0.1W	5%	10K Ω	
R2356	ERJ6GEYJ103	S.M.CARB	0.1W	5%	10K Ω	
R2357	ERJ6GEYJ562	S.M.CARB	0.1W	5%	5K6 Ω	
R2358	ERJ6GEYJ562	S.M.CARB	0.1W	5%	5K6 Ω	
R2359	ERJ6GEYJ393	S.M.CARB	0.1W	5%	39K Ω	
R2361	ERJ6GEYJ223	S.M.CARB	0.1W	5%	22K Ω	
R2362	ERJ6GEYJ103	S.M.CARB	0.1W	5%	10K Ω	
R2363	ERJ6GEYJ103	S.M.CARB	0.1W	5%	10K Ω	
R2364	ERD25TJ101	CARBON	0.25W	5%	100 Ω	
R2365	ERJ6GEYJ102	S.M.CARB	0.1W	5%	1K Ω	
R2368	ERJ6GEYJ222	S.M.CARB	0.1W	5%	2K2 Ω	
R2369	ERJ6GEYJ222	S.M.CARB	0.1W	5%	2K2 Ω	
R2370	ERJ6GEYJ103	S.M.CARB	0.1W	5%	10K Ω	
R2371	ERJ6GEYJ103	S.M.CARB	0.1W	5%	10K Ω	
R2372	ERJ6GEYJ562	S.M.CARB	0.1W	5%	5K6 Ω	
R2373	ERJ6GEYJ562	S.M.CARB	0.1W	5%	5K6 Ω	
R2376	ERJ6GEYJ103	S.M.CARB	0.1W	5%	10K Ω	
R2377	ERJ6GEYJ103	S.M.CARB	0.1W	5%	10K Ω	
R2459	ERJ6GEY0R00	S.M.CARB	0.1W	5%	0 Ω	
R2460	ERJ6GEY0R00	S.M.CARB	0.1W	5%	0 Ω	
R2474	ERJ6GEYJ101	S.M.CARB	0.1W	5%	100 Ω	
R2475	ERJ6GEYJ101	S.M.CARB	0.1W	5%	100 Ω	
R3005	ERJ6GEYJ104	S.M.CARB	0.1W	5%	100K Ω	
R3006	ERJ6GEYJ221	S.M.CARB	0.1W	5%	220 Ω	
R3007	ERJ6GEY0R00	S.M.CARB	0.1W	5%	0 Ω	
R3008	ERJ6GEYJ470	S.M.CARB	0.1W	5%	47 Ω	
R3009	ERJ6GEYJ470	S.M.CARB	0.1W	5%	47 Ω	
R3010	ERJ6GEYJ104	S.M.CARB	0.1W	5%	100K Ω	
R3012	ERJ6GEYJ104	S.M.CARB	0.1W	5%	100K Ω	
R3013	ERJ6GEYJ101	S.M.CARB	0.1W	5%	100 Ω	
R3014	ERJ6GEYJ101	S.M.CARB	0.1W	5%	100 Ω	
R3015	ERJ6GEYJ470	S.M.CARB	0.1W	5%	47 Ω	
R3016	ERJ6GEYJ121	S.M.CARB	0.1W	5%	120 Ω	
R3017	ERJ6GEYJ390	S.M.CARB	0.1W	5%	39 Ω	
R3018	ERJ6GEYJ101	S.M.CARB	0.1W	5%	100 Ω	
R3019	ERJ6GEYJ101	S.M.CARB	0.1W	5%	100 Ω	
R3020	ERJ6GEYJ101	S.M.CARB	0.1W	5%	100 Ω	
R3021	ERJ6GEYJ681	S.M.CARB	0.1W	5%	680 Ω	

Cct Ref	Parts Number	Description				
R3022	ERJ6GEYJ680	S.M.CARB	0.1W	5%	68 Ω	
R3023	ERQ14AJ390	FUSIBLE	0.25W	5%	39 Ω	△
R3024	ERJ6GEYJ683	S.M.CARB	0.1W	5%	68K Ω	
R3025	ERJ6GEYJ153	S.M.CARB	0.1W	5%	15K Ω	
R3026	ERJ6GEYJ221	S.M.CARB	0.1W	5%	220 Ω	
R3027	ERJ6GEYJ100	S.M.CARB	0.1W	5%	10 Ω	
R3028	ERJ6GEYJ681	S.M.CARB	0.1W	5%	680 Ω	
R3029	ERJ6GEYJ100	S.M.CARB	0.1W	5%	10 Ω	
R3030	ERJ6GEYJ153	S.M.CARB	0.1W	5%	15K Ω	
R3031	ERJ6GEYJ472	S.M.CARB	0.1W	5%	4K7 Ω	
R3035	ERJ6GEYJ103	S.M.CARB	0.1W	5%	10K Ω	
R3036	ERJ6GEYJ101	S.M.CARB	0.1W	5%	100 Ω	
R3037	ERJ6GEYJ103	S.M.CARB	0.1W	5%	10K Ω	
R3038	ERJ6GEYJ332	S.M.CARB	0.1W	5%	3K3 Ω	
R3039	ERJ6GEYJ332	S.M.CARB	0.1W	5%	3K3 Ω	
R3040	ERJ6GEYJ101	S.M.CARB	0.1W	5%	100 Ω	
R3043	ERJ6GEYJ471	S.M.CARB	0.1W	5%	470 Ω	
R3045	ERJ6GEY0R00	S.M.CARB	0.1W	5%	0 Ω	
R3046	ERJ6GEYJ102	S.M.CARB	0.1W	5%	1K Ω	
R3047	ERJ6GEY0R00	S.M.CARB	0.1W	5%	0 Ω	
R3048	ERJ6GEYJ102	S.M.CARB	0.1W	5%	1K Ω	
R3053	ERJ6GEYJ220	S.M.CARB	0.1W	5%	22 Ω	
R3057	ERJ6GEYJ151	S.M.CARB	0.1W	5%	150 Ω	
R3058	ERJ6GEYJ104	S.M.CARB	0.1W	5%	100K Ω	
R3059	ERJ6GEYJ102	S.M.CARB	0.1W	5%	1K Ω	
R3060	ERJ6GEYJ471	S.M.CARB	0.1W	5%	470 Ω	
R3061	ERJ6GEYJ562	S.M.CARB	0.1W	5%	5K6 Ω	
R3062	ERJ6GEYJ562	S.M.CARB	0.1W	5%	5K6 Ω	
R3063	ERJ6GEYJ222	S.M.CARB	0.1W	5%	2K2 Ω	
R3064	ERJ6GEYJ272	S.M.CARB	0.1W	5%	2K7 Ω	
R3065	ERJ6GEYJ333	S.M.CARB	0.1W	5%	33K Ω	
R3066	ERJ6GEYJ471	S.M.CARB	0.1W	5%	470 Ω	
R3067	ERJ6GEYJ102	S.M.CARB	0.1W	5%	1K Ω	
R3068	ERJ6GEYJ563	S.M.CARB	0.1W	5%	56K Ω	
R3069	ERJ6GEYJ183	S.M.CARB	0.1W	5%	18K Ω	
R3070	ERJ6GEYJ102	S.M.CARB	0.1W	5%	1K Ω	
R3071	ERJ6GEYJ621	S.M. CAR	0.1W	5%	620 Ω	
R3072	ERJ6GEYJ103	S.M.CARB	0.1W	5%	10K Ω	
R3073	ERJ6GEYJ393	S.M.CARB	0.1W	5%	39K Ω	
R3074	ERJ6GEYJ473	S.M.CARB	0.1W	5%	47K Ω	
R3075	ERJ6GEYJ472	S.M.CARB	0.1W	5%	4K7 Ω	
R3076	ERJ6GEYJ331	S.M.CARB	0.1W	5%	330 Ω	
R3077	ERJ6GEYJ101	S.M.CARB	0.1W	5%	100 Ω	
R3078	ERJ6GEY0R00	S.M.CARB	0.1W	5%	0 Ω	
R3079	ERJ6GEYJ101	S.M.CARB	0.1W	5%	100 Ω	
R3080	ERJ6GEYJ101	S.M.CARB	0.1W	5%	100 Ω	
R3081	ERJ6GEYJ101	S.M.CARB	0.1W	5%	100 Ω	
R3082	ERJ6GEYJ101	S.M.CARB	0.1W	5%	100 Ω	
R3087	ERJ6GEYJ750	S.M.CARB	0.1W	5%	75 Ω	
R3113	ERJ6GEYJ101	S.M.CARB	0.1W	5%	100 Ω	
R3114	ERJ6GEYJ101	S.M.CARB	0.1W	5%	100 Ω	
R3125	ERJ6GEYJ681	S.M.CARB	0.1W	5%	680 Ω	
R3126	ERJ6GEYJ681	S.M.CARB	0.1W	5%	680 Ω	
R3281	ERD25TJ750	CARBON	0.25W	5%	75 Ω	
R3282	ERD25TJ750	CARBON	0.25W	5%	75 Ω	
R3284	ERD25TJ102	CARBON	0.25W	5%	1K Ω	
R3285	ERD25TJ102	CARBON	0.25W	5%	1K Ω	
R3351	ERJ6GEYJ220	S.M.CARB	0.1W	5%	22 Ω	
R3352	ERJ6GEYJ472	S.M.CARB	0.1W	5%	4K7 Ω	
R3353	ERJ6GEYJ474	S.M.CARB	0.1W	5%	470K Ω	
R3354	ERJ6GEYJ102	S.M.CARB	0.1W	5%	1K Ω	
R3355	ERJ6GEYJ391	S.M.CARB	0.1W	5%	390 Ω	
R3356	ERJ6GEYJ682	S.M.CARB	0.1W	5%	6K8 Ω	
R3357	ERJ6GEYJ682	S.M.CARB	0.1W	5%	6K8 Ω	
R3358	ERJ6GEYJ682	S.M.CARB	0.1W	5%	6K8 Ω	
R3360	ERDS1TJ471	CARBON	0.5W	5%	470 Ω	

Cct Ref	Parts Number	Description			
R3361	ERO50PKF1133	METAL	0.5W	5%	110K Ω [△]
R3401	ERJ6GEYJ101	S.M.CARB	0.1W	5%	100 Ω
R3402	ERJ6GEYJ101	S.M.CARB	0.1W	5%	100 Ω
R3403	ERJ6GEYJ333	S.M.CARB	0.1W	5%	33K Ω
R3404	ERJ6GEYJ333	S.M.CARB	0.1W	5%	33K Ω
R3405	ERJ6GEYJ102	S.M.CARB	0.1W	5%	1K Ω
R3406	ERJ6GEYJ102	S.M.CARB	0.1W	5%	1K Ω
R3407	ERJ6GEYJ153	S.M.CARB	0.1W	5%	15K Ω
R3408	ERJ6GEYJ102	S.M.CARB	0.1W	5%	1K Ω
R3409	ERJ6GEYJ102	S.M.CARB	0.1W	5%	1K Ω
R3410	ERJ6GEYJ104	S.M.CARB	0.1W	5%	100K Ω
R3412	ERJ6GEYJ102	S.M.CARB	0.1W	5%	1K Ω
R3413	ERJ6GEYJ102	S.M.CARB	0.1W	5%	1K Ω
R3414	ERJ6GEYJ750	S.M.CARB	0.1W	5%	75 Ω
R3415	ERJ6GEYJ104	S.M.CARB	0.1W	5%	100K Ω
R3416	ERJ6GEYJ333	S.M.CARB	0.1W	5%	33K Ω
R3417	ERJ6GEYJ104	S.M.CARB	0.1W	5%	100K Ω
R3418	ERJ6GEYJ104	S.M.CARB	0.1W	5%	100K Ω
R3419	ERJ6GEYJ333	S.M.CARB	0.1W	5%	33K Ω
R3420	ERJ6GEYJ750	S.M.CARB	0.1W	5%	75 Ω
R3421	ERJ6GEYJ750	S.M.CARB	0.1W	5%	75 Ω
R3422	ERJ6GEYJ153	S.M.CARB	0.1W	5%	15K Ω
R3423	ERJ6GEYJ470	S.M.CARB	0.1W	5%	47 Ω
R3424	ERJ6GEYJ101	S.M.CARB	0.1W	5%	100 Ω
R3425	ERJ6GEYJ221	S.M.CARB	0.1W	5%	220 Ω
R3426	ERJ6GEYJ680	S.M.CARB	0.1W	5%	68 Ω
R3427	ERJ6GEYJ102	S.M.CARB	0.1W	5%	1K Ω
R3428	ERJ6GEYJ680	S.M.CARB	0.1W	5%	68 Ω
R3430	ERJ6GEYJ103	S.M.CARB	0.1W	5%	10K Ω
R3433	ERJ6GEYJ332	S.M.CARB	0.1W	5%	3K3 Ω
R3446	ERJ6GEYJ102	S.M.CARB	0.1W	5%	1K Ω
R3447	ERJ6GEYJ102	S.M.CARB	0.1W	5%	1K Ω
R3452	ERJ6GEYJ101	S.M.CARB	0.1W	5%	100 Ω
R3453	ERJ6GEYJ101	S.M.CARB	0.1W	5%	100 Ω
R3454	ERJ6GEYJ101	S.M.CARB	0.1W	5%	100 Ω
R3455	ERJ6GEYJ101	S.M.CARB	0.1W	5%	100 Ω
R3801	ERJ6GEYJ101	S.M.CARB	0.1W	5%	100 Ω
R3802	ERJ6GEYJ221	S.M.CARB	0.1W	5%	220 Ω
R3803	ERG3FJ100	METAL	3W	5%	10 Ω [△]
R3990	ERJ6GEYJ472	S.M.CARB	0.1W	5%	4K7 Ω
R3991	ERJ6GEYJ103	S.M.CARB	0.1W	5%	10K Ω
R3992	ERJ6GEYJ103	S.M.CARB	0.1W	5%	10K Ω
R3993	ERJ6GEYJ103	S.M.CARB	0.1W	5%	10K Ω
R3994	ERJ6GEYJ103	S.M.CARB	0.1W	5%	10K Ω
CAPACITORS					
C002	ECA1HMR33GB	ELECT	50V		0.33U
C003	ECJ2VF1H104Z	ELECT	350V		100nF
C004	ECJ2VF1H104Z	ELECT	350V		100nF
C005	ECA1CM221GB	ELECT	16V		220μF
C006	ECJ2VF1H104Z	ELECT	350V		100nF
C007	ECJ2VF1H104Z	ELECT	350V		100nF
C008	ECUV1H561JCX	S.M. CAP	50V		560pF
C009	ECA1CM221GB	ELECT	16V		220μF
C010	ECA1HM4R7GB	ELECT	50V		4.7μF
C011	ECUV1H100DCX	S.M. CAP	50V		10pF
C012	ECUV1H100DCX	S.M. CAP	50V		10pF
C013	ECA1CM470GB	ELECT	16V		47μF
C014	ECJ2VF1H104Z	ELECT	350V		100nF
C015	ECJ2VF1H104Z	ELECT	350V		100nF
C017	ECUV1H100DCX	S.M. CAP	50V		10pF
C018	ECJ2VF1H104Z	ELECT	350V		100nF
C019	ECJ2VF1H104Z	ELECT	350V		100nF
C103	ECJ2VF1H104Z	ELECT	350V		100nF
C104	ECJ2VF1H103Z	ELECT	350V		10nF
C107	ECJ2VF1H104Z	ELECT	350V		100nF
C108	ECJ2VF1H104Z	ELECT	350V		100nF

Cct Ref	Parts Number	Description			
C109	ECUY1C184KBX	S.M. CAP	16V		180nF
C110	ECJ2VF1H104Z	ELECT	350V		100nF
C111	ECJ2VF1H104Z	ELECT	350V		100nF
C251	ECA1CM220GB	ELECT	16V		22μF
C252	ECUV1H103KBX	S.M. CAP	50V		10nF
C253	ECA1HM4R7GB	ELECT	50V		4.7μF
C254	ECQM1H683J	FILM	50V		68nF
C255	ECA1EHG101B	ELECT	50V		100nF
C256	ECUV1H103KBX	S.M. CAP	50V		10nF
C257	ECA1HM4R7GB	ELECT	50V		4.7μF
C258	ECA1CM220GB	ELECT	16V		22μF
C259	ECQM1H683J	FILM	50V		68nF
C260	ECA1VM102GB	ELECT	35V		1nF
C261	ECA1VM102GB	ELECT	35V		1nF
C262	ECQM1H184J	FILM	50V		1nF
C263	ECA1HM100GB	ELECT	50V		10μF
C264	ECA1HM222E	ELECT	50V		2.2nF
C265	ECQM1H184J	FILM	50V		2.2nF
C266	ECA1HM100GB	ELECT	50V		10μF
C267	ECQM1H224J	FILM	50V		220nF
C268	ECQM1H224J	FILM	50V		220nF
C269	ECA1HM470GB	ELECT	50V		47μF
C270	ECQM1H224J	FILM	50V		220nF
C271	ECQM1H224J	FILM	50V		220nF
C277	ECUV1H102JCX	S.M. CAP	50V		1nF
C278	ECUV1H102JCX	S.M. CAP	50V		1nF
C352	ECUV1H224ZFX	S.M. CAP	50V		220nF
C353	ECUV1H104KBX	S.M. CAP	50V		100nF
C354	ECQM2104KZ	FILM	250V		100nF
C355	ECKC2H102J	CERAMIC	500V		1nF [△]
C362	ECUV1H224ZFX	S.M. CAP	50V		220nF
C363	ECUV1H104KBX	S.M. CAP	50V		100nF
C364	ECQM2104KZ	FILM	250V		100nF
C365	ECKC2H102J	CERAMIC	500V		1nF [△]
C372	ECUV1H224ZFX	S.M. CAP	50V		220nF
C373	ECUV1H104KBX	S.M. CAP	50V		100nF
C374	ECQM2104KZ	FILM	250V		100nF
C375	ECKC2H102J	CERAMIC	500V		1nF [△]
C381	ECA1HM101GB	ELECT	50V		100μF
C382	ECA1CM471GB	ELECT	16V		470μF
C383	ECUV1H103KBX	S.M. CAP	50V		10nF
C384	ECQM2104KZ	FILM	250V		100nF
C385	ECA2EM220B	ELECT	250V		22μF
C386	ECKC3D152J	CERAMIC	2KV		1.5nF [△]
C388	ECUV1H331KBX	S.M. CAP	50V		330pF
C389	ECUV1H331KBX	S.M. CAP	50V		330pF
C390	ECUV1H150JCX	S.M. CAP	50V		15pF
C391	ECUV1H150JCX	S.M. CAP	50V		15pF
C392	ECUV1H150JCX	S.M. CAP	50V		15pF
C395	ECQM1H104J	FILM	50V		100nF
C396	ECJ2VF1H104Z	ELECT	350V		100nF
C400	ECA1VM102GB	ELECT	35V		1nF
C402	ECA1HM010GB	ELECT	50V		1μF
C404	ECEA1HU471	ELECT	50V		470μF
C405	ECA1EM102GB	ELECT	25V		100μF
C407	ECQB1224KFW	FILM	100V		220nF
C411	ECUV1H102KBX	S.M. CAP	50V		1nF
C501	ECQM1H224J	FILM	50V		220nF
C502	ECQM2104KZ	FILM	250V		100nF
C503	ECKC2H102J	CERAMIC	500V		1nF [△]
C504	ECQB1H223K	FILM	50V		22nF
C505	ECA1EM222GB	ELECT	25V		22nF
C506	ECKC2H102J	CERAMIC	500V		1nF [△]
C507	ECA1EM332E	ELECT	25V		1nF
C552	ECWH20102JVY	FILM	200V		1μF
C553	ECQP1223JZW	FILM	100V		22nF

Cct Ref	Parts Number	Description			
C554	ECQB1H152K	FILM	50V	1.5nF	
C555	ECWH20562JVB	FILM	200V	5.6nF	
C556	ECEA2CNR47SB	ELECT	160V	5.6nF	
C557	ECKC2H331J	CERAMIC	500V	330pF	△
C558	ECA2EM330B	ELECT	250V	33µF	
C559	ECKC2H103J	CERAMIC	50V	10nF	△
C563	ECWF2564JBB	FILM	200V	560nF	△
C564	ECKC1H103JB	CERAMIC	50V	10nF	
C565	ECQP1223JZW	FILM	100V	22nF	
C572	ECWH20682JVB	FILM	200V	6.8nF	
C573	ECQF4153JZH	FILM	400V	1.5nF	△
C574	ECWF4824JBB	FILM	400V	820nF	
C575	ECWF4564JBB	FILM	400V	560nF	
C581	ECQM4223KC	FILM	400V	220nF	
C584	ECKC3D391J	CERAMIC	2KV	390pF	△
C602	ECJ2VF1H104Z	ELECT	350V	100nF	
C603	ECJ2VF1H104Z	ELECT	350V	100nF	
C604	ECUV1H470JCX	S.M. CAP	50V	47pF	
C605	ECA1CM221GB	ELECT	16V	220µF	
C606	ECA1AM332E	ELECT	10V	220µF	
C607	ECJ2VF1H104Z	ELECT	350V	100nF	
C608	ECJ2VF1H104Z	ELECT	350V	100nF	
C609	ECA1HM3R3GB	ELECT	50V	3.3µF	
C610	ECJ2VF1H104Z	ELECT	350V	100nF	
C611	ECJ2VF1H104Z	ELECT	350V	100nF	
C612	ECJ2VF1H104Z	ELECT	350V	100nF	
C613	ECJ2VF1H104Z	ELECT	350V	100nF	
C614	ECJ2VF1H104Z	ELECT	350V	100nF	
C615	ECJ2VB1C104K	ELECT	350V	100nF	
C616	ECQM1H104J	FILM	50V	100nF	
C617	ECJ2VF1H104Z	ELECT	350V	100nF	
C618	ECJ2VF1H104Z	ELECT	350V	100nF	
C620	ECUV1H100DCX	S.M. CAP	50V	10pF	
C622	ECUV1H470JCX	S.M. CAP	50V	47pF	
C623	ECUV1H470JCX	S.M. CAP	50V	47pF	
C624	ECUV1H820JCX	S.M. CAP	50V	82pF	
C625	ECUV1H470JCX	S.M. CAP	50V	47pF	
C626	ECUV1H470JCX	S.M. CAP	50V	47pF	
C627	ECUV1H470JCX	S.M. CAP	50V	47pF	
C628	ECUV1H470JCX	S.M. CAP	50V	47pF	
C632	ECJ2VF1H104Z	ELECT	350V	100nF	
C633	ECJ2VF1H104Z	ELECT	350V	100nF	
C635	ECA1EM101GB	ELECT	25V	100µF	
C636	ECUV1H103ZFX	S.M. CAP	50V	10nF	
C637	ECUV1H470JCX	S.M. CAP	50V	47pF	
C638	ECUV1H270JCX	S.M. CAP	50V	27pF	
C639	ECJ2VF1H104Z	ELECT	350V	100nF	
C641	ECUV1H101JCX	S.M. CAP	50V	100pF	
C643	ECUV1H102KBX	S.M. CAP	50V	1nF	
C644	ECQM1H104J	FILM	50V	100nF	
C645	ECQM1H104J	FILM	50V	100nF	
C646	ECUV1H103KBX	S.M. CAP	50V	10nF	
C651	ECJ2VB1C224K	ELECT	350V	220nF	
C701	ECQV1H105JZ	FILM	50V	1µF	
C702	ECKC2H102J	CERAMIC	500V	1nF	△
C806	ECQE6104K	FILM	600V	100nF	△
C807	ECQB1H473K	FILM	50V	47nF	
C808	ECQM1H334J	FILM	50V	330nF	
C811	ECQB1H104J	FILM	50V	100nF	
C812	ECQB1H562K	FILM	50V	5.6nF	
C813	ECKC2H472J	CERAMIC	500V	4.7nF	△
C814	ECKC2H472J	CERAMIC	500V	4.7nF	△
C816	ECQB1H122J	FILM	50V	1.2nF	
C817	ECKC2H472J	CERAMIC	500V	4.7nF	△
C818	ECKC2H472J	CERAMIC	500V	4.7nF	△
C819	ECOS2WB221DB	ELECT	16V	220µF	

Cct Ref	Parts Number	Description			
C821	ECQB1H222J	FILM	50V	2.2nF	
C822	ECKC3D821JB	CERAMIC	2KV	2.2nF	△
C823	EEUFA1V221B	CERAMIC	35V	220µF	
C824	ECQB1H221KF3	FILM	50V	220µF	
C826	ECQB1H473K	FILM	50V	47nF	
C827	ECKCNS332J	CERAMIC	1.2KV	3.3nF	△
C833	ECQB1H682K	FILM	50V	6.8nF	
C835	ECQB1H332K	FILM	50V	3.3nF	
C840	222233510224	FILM	250V	220nF	
C841	ECQE2A474MWB	FILM	250V	470nF	
C847	ECEA1EN101UB	ELECT	25V	100µF	
C848	ECKC2H331J	CERAMIC	500V	330pF	△
C849	ECKC2H391J	CERAMIC	500V	390pF	△
C850	ECKC3D331J	CERAMIC	2KV	330pF	△
C852	ECKC3D222JB	CERAMIC	2KV	330pF	△
C853	ECEA1CU332	ELECT	16V	330pF	
C854	ECA1EM221GB	ELECT	25V	330pF	
C855	ECEA1HU102	ELECT	50V	330pF	
C856	ECA1EM332E	ELECT	25V	330pF	
C857	ECA1EM471GB	ELECT	25V	470µF	
C858	43504A2277M0	ELECT	400V	270µF	
C859	ECKC2H471J	CERAMIC	500V	470pF	△
C861	222215990032	FILM	250V	220µF	
C863	ECA1EM332E	ELECT	25V	220µF	
C864	ECA0JM102GB	ELECT	6.3V	220µF	
C866	ECA1HM101GB	ELECT	50V	100µF	
C867	ECA1CM222E	ELECT	16V	2.2nF	
C868	ECA1CM100GB	ELECT	16V	10µF	
C869	ECA1HM101GB	ELECT	50V	100µF	
C871	ECA0JM102GB	ELECT	6.3V	100µF	
C872	ECA1CM222E	ELECT	16V	2.2nF	
C901	ECUV1H030CCX	S.M. CAP	50V	30pF	
C902	ECA1VM101GB	ELECT	35V	100µF	
C904	ECJ2VF1H103Z	ELECT	350V	10nF	
C906	ECUV1H681JCX	S.M. CAP	50V	680pF	
C909	ECKC2H472J	CERAMIC	500V	4.7nF	△
C910	ECKC2H472J	CERAMIC	500V	4.7nF	△
C912	ECA2EM220B	ELECT	250V	22µF	
C913	ECA1HM101GB	ELECT	50V	100µF	
C914	ECA1HM101GB	ELECT	50V	100µF	
C916	ECA2EM220B	ELECT	250V	22µF	
C917	ECA1HM100GB	ELECT	50V	10µF	
C918	ECJ2VF1H103Z	ELECT	350V	10nF	
C1011	ECKC1H101J	CERAMIC	50V	100pF	
C1012	ECA1VM470B	ELECT	35V	47µF	
C1013	ECKC1H103JB	CERAMIC	50V	10nF	
C1014	ECA1HM101GB	ELECT	50V	100µF	
C1101	ECJ2VF1H104Z	ELECT	350V	100nF	
C1102	ECUV1H101JCX	S.M. CAP	50V	100pF	
C1103	ECUV1H220JCX	S.M. CAP	50V	22pF	
C1104	ECUV1H220JCX	S.M. CAP	50V	22pF	
C1107	ECJ2VF1H104Z	ELECT	350V	100nF	
C1108	ECJ2VB1C104K	ELECT	350V	100nF	
C1109	ECJ2VB1C104K	ELECT	350V	100nF	
C1113	ECJ2VB1C104K	ELECT	350V	100nF	
C1114	ECA1HM101GB	ELECT	50V	100µF	
C1116	ECUV1H560JCX	S.M. CAP	50V	56pF	
C1117	ECUV1H221JCX	S.M. CAP	50V	220pF	
C1118	ECJ3VB1C474K	ELECT	3.5KV	470nF	
C1120	ECJ2VF1H104Z	ELECT	350V	100nF	
C1121	ECUV1H472KBX	S.M. CAP	50V	4.7nF	
C1122	ECA1HM010GB	ELECT	50V	1µF	
C1123	ECJ2VF1H104Z	ELECT	350V	100nF	
C1124	ECUV1H471JCX	S.M. CAP	50V	470pF	
C1125	ECJ2VF1H104Z	ELECT	350V	100nF	
C1126	ECJ2VF1H104Z	ELECT	350V	100nF	

Cct Ref	Parts Number	Description			
C1127	ECA1HM101GB	ELECT	50V	100µF	
C1128	ECJ2VF1H104Z	ELECT	350V	100nF	
C1129	ECA1HM101GB	ELECT	50V	100µF	
C1130	ECUV1H103KBX	S.M. CAP	50V	10nF	
C1131	ECUV1H221JCX	S.M. CAP	50V	220pF	
C1138	ECUV1H224ZFX	S.M. CAP	50V	220nF	
C1145	ECJ2VB1H333K	ELECT	350V	33nF	
C1147	ECA1CM331B	ELECT	16V	330µF	
C1148	ECJ2VB1C224K	ELECT	350V	220nF	
C1501	ECUV1H330JCX	S.M. CAP	50V	33pF	
C1502	ECUV1H471JCX	S.M. CAP	50V	470pF	
C1503	ECUV1H390JCX	S.M. CAP	50V	39pF	
C1504	ECUV1H680JCX	S.M. CAP	50V	68pF	
C1505	ECUV1H820JCX	S.M. CAP	50V	82pF	
C1506	ECUV1H331JCX	S.M. CAP	50V	330pF	
C1507	ECUV1H102KBX	S.M. CAP	50V	1nF	
C1508	ECEA1HN010UB	ELECT	50V	1µF	
C1509	ECJ2VF1H104Z	ELECT	350V	100nF	
C1510	ECA1HM101GB	ELECT	50V	100µF	
C1511	ECJ2VF1H104Z	ELECT	350V	100nF	
C1512	ECUV1H030CCX	S.M. CAP	50V	30pF	
C1513	ECA1HM100GB	ELECT	50V	10µF	
C1514	ECJ2VF1H104Z	ELECT	350V	100nF	
C1515	ECJ2VF1H104Z	ELECT	350V	100nF	
C1516	ECUV1H030CCX	S.M. CAP	50V	30pF	
C1517	ECUV1H473ZFX	S.M. CAP	50V	47nF	
C1518	ECJ2VF1H104Z	ELECT	350V	100nF	
C1519	ECA1HM101GB	ELECT	50V	100µF	
C1521	ECA1HM101GB	ELECT	50V	100µF	
C1522	ECJ2VF1H104Z	ELECT	350V	100nF	
C1523	ECJ2VF1H104Z	ELECT	350V	100nF	
C1524	ECA1VM470B	ELECT	35V	47µF	
C1525	ECJ2VF1H104Z	ELECT	350V	100nF	
C1527	ECJ2VF1H104Z	ELECT	350V	100nF	
C1528	ECJ2VF1H104Z	ELECT	350V	100nF	
C1529	ECJ2VF1H104Z	ELECT	350V	100nF	
C1530	ECJ2VF1H104Z	ELECT	350V	100nF	
C1532	ECJ2VF1H104Z	ELECT	350V	100nF	
C1533	ECJ2VF1H104Z	ELECT	350V	100nF	
C1534	ECJ2VF1H104Z	ELECT	350V	100nF	
C1535	ECJ2VF1H104Z	ELECT	350V	100nF	
C1536	ECJ2VF1H104Z	ELECT	350V	100nF	
C1537	ECJ2VF1H104Z	ELECT	350V	100nF	
C1538	EEUNA1E220B	CERAMIC	25V	22µF	
C1539	ECJ2VF1H104Z	ELECT	350V	100nF	
C1540	ECJ2VF1H104Z	ELECT	350V	100nF	
C1541	ECJ2VF1H104Z	ELECT	350V	100nF	
C1542	ECA1CM471GB	ELECT	16V	470µF	
C1543	ECJ2VF1H104Z	ELECT	350V	100nF	
C1544	EEUNA1E220B	CERAMIC	25V	22µF	
C1545	ECJ2VF1H104Z	ELECT	350V	100nF	
C1546	ECA1HM101GB	ELECT	50V	100µF	
C1547	ECJ2VF1H104Z	ELECT	350V	100nF	
C1548	ECJ2VF1H104Z	ELECT	350V	100nF	
C1549	ECJ2VF1H104Z	ELECT	350V	100nF	
C1550	ECJ2VF1H104Z	ELECT	350V	100nF	
C1551	EEUNA1E220B	CERAMIC	25V	22µF	
C1552	ECA1HM101GB	ELECT	50V	100µF	
C1553	ECJ2VF1H104Z	ELECT	350V	100nF	
C1554	ECJ2VF1H104Z	ELECT	350V	100nF	
C1555	ECJ2VF1H104Z	ELECT	350V	100nF	
C1556	ECA1HM101GB	ELECT	50V	100µF	
C1557	ECJ2VF1H104Z	ELECT	350V	100nF	
C1558	ECJ2VF1H104Z	ELECT	350V	100nF	
C1559	ECJ2VF1H104Z	ELECT	350V	100nF	
C1560	ECJ2VF1H104Z	ELECT	350V	100nF	

Cct Ref	Parts Number	Description			
C1561	ECJ2VF1H104Z	ELECT	350V	100nF	
C1562	ECJ2VF1H104Z	ELECT	350V	100nF	
C1563	ECA1HM101GB	ELECT	50V	100µF	
C1564	ECJ2VF1H104Z	ELECT	350V	100nF	
C1565	ECUV1H270JCX	S.M. CAP	50V	27pF	
C1567	ECA1HM101GB	ELECT	50V	100µF	
C1568	ECJ2VF1H104Z	ELECT	350V	100nF	
C1569	ECJ2VF1H104Z	ELECT	350V	100nF	
C1570	ECJ2VF1H104Z	ELECT	350V	100nF	
C1571	ECA1CM471GB	ELECT	16V	470µF	
C1572	ECJ2VF1H104Z	ELECT	350V	100nF	
C1573	ECJ2VF1H104Z	ELECT	350V	100nF	
C1574	ECJ2VF1H104Z	ELECT	350V	100nF	
C1575	ECJ2VF1H104Z	ELECT	350V	100nF	
C1576	ECJ2VF1H104Z	ELECT	350V	100nF	
C1577	ECJ2VF1H104Z	ELECT	350V	100nF	
C1578	ECJ2VF1H104Z	ELECT	350V	100nF	
C1579	ECJ2VF1H104Z	ELECT	350V	100nF	
C1580	ECJ2VF1H104Z	ELECT	350V	100nF	
C1581	ECJ2VF1H104Z	ELECT	350V	100nF	
C1582	ECJ2VF1H104Z	ELECT	350V	100nF	
C1583	ECJ2VF1H104Z	ELECT	350V	100nF	
C1584	ECJ2VF1H104Z	ELECT	350V	100nF	
C1585	ECJ2VF1H104Z	ELECT	350V	100nF	
C1586	ECJ2VF1H104Z	ELECT	350V	100nF	
C1587	ECJ2VF1H104Z	ELECT	350V	100nF	
C1588	ECJ2VF1H104Z	ELECT	350V	100nF	
C1589	ECJ2VF1H104Z	ELECT	350V	100nF	
C1590	ECJ2VF1H104Z	ELECT	350V	100nF	
C1591	ECJ2VF1H104Z	ELECT	350V	100nF	
C1592	ECA1CM221GB	ELECT	16V	220µF	
C1593	ECA1CM221GB	ELECT	16V	220µF	
C1594	ECJ2VF1H104Z	ELECT	350V	100nF	
C1595	ECJ2VF1H104Z	ELECT	350V	100nF	
C1596	ECJ2VF1H104Z	ELECT	350V	100nF	
C1597	ECJ2VF1H104Z	ELECT	350V	100nF	
C1598	ECJ2VF1H104Z	ELECT	350V	100nF	
C1599	ECJ2VF1H104Z	ELECT	350V	100nF	
C1600	ECJ2VF1H104Z	ELECT	350V	100nF	
C1601	ECJ2VF1H104Z	ELECT	350V	100nF	
C1602	ECJ2VF1H104Z	ELECT	350V	100nF	
C1603	ECJ2VF1H104Z	ELECT	350V	100nF	
C1604	ECJ2VF1H104Z	ELECT	350V	100nF	
C1605	ECJ2VF1H104Z	ELECT	350V	100nF	
C1606	ECJ2VF1H104Z	ELECT	350V	100nF	
C1607	ECJ2VF1H104Z	ELECT	350V	100nF	
C1608	ECJ2VF1H104Z	ELECT	350V	100nF	
C1609	ECJ2VF1H104Z	ELECT	350V	100nF	
C1610	ECJ2VF1H104Z	ELECT	350V	100nF	
C1611	ECA1CM471GB	ELECT	16V	470µF	
C1612	ECJ2VF1H104Z	ELECT	350V	100nF	
C1614	ECJ2VF1H104Z	ELECT	350V	100nF	
C1615	ECJ2VF1H104Z	ELECT	350V	100nF	
C1616	ECJ2VF1H104Z	ELECT	350V	100nF	
C1617	ECJ2VF1H104Z	ELECT	350V	100nF	
C1618	ECJ2VF1H104Z	ELECT	350V	100nF	
C1619	ECJ2VF1H104Z	ELECT	350V	100nF	
C1620	ECJ2VF1H104Z	ELECT	350V	100nF	
C1621	ECJ2VF1H104Z	ELECT	350V	100nF	
C1622	ECJ2VF1H104Z	ELECT	350V	100nF	
C1623	ECJ2VF1H104Z	ELECT	350V	100nF	
C1624	ECJ2VF1H104Z	ELECT	350V	100nF	
C1625	ECJ2VF1H104Z	ELECT	350V	100nF	
C1626	ECJ2VF1H104Z	ELECT	350V	100nF	
C1627	ECJ2VF1H104Z	ELECT	350V	100nF	
C1628	ECJ2VF1H104Z	ELECT	350V	100nF	

Cct Ref	Parts Number	Description			
C1629	ECJ2VF1H104Z	ELECT	350V	100nF	
C1630	ECJ2VF1H104Z	ELECT	350V	100nF	
C1631	ECJ2VF1H104Z	ELECT	350V	100nF	
C1632	ECJ2VF1H104Z	ELECT	350V	100nF	
C1633	ECJ2VF1H104Z	ELECT	350V	100nF	
C1636	ECJ2VF1H104Z	ELECT	350V	100nF	
C1637	ECJ2VF1H104Z	ELECT	350V	100nF	
C1638	ECJ2VF1H104Z	ELECT	350V	100nF	
C1639	ECJ2VF1H104Z	ELECT	350V	100nF	
C1642	ECJ2VF1H104Z	ELECT	350V	100nF	
C1643	ECJ2VF1H104Z	ELECT	350V	100nF	
C1644	ECJ2VF1H104Z	ELECT	350V	100nF	
C1645	ECJ2VF1H104Z	ELECT	350V	100nF	
C1647	ECUV1H470JCX	S.M. CAP	50V	47pF	
C1648	ECJ2VF1H104Z	ELECT	350V	100nF	
C1649	ECA1HM101GB	ELECT	50V	100µF	
C1650	ECJ2VF1H104Z	ELECT	350V	100nF	
C1651	ECJ2VF1H104Z	ELECT	350V	100nF	
C1652	ECA1HM101GB	ELECT	50V	100µF	
C1653	ECJ2VF1H104Z	ELECT	350V	100nF	
C1654	ECJ2VF1H104Z	ELECT	350V	100nF	
C1655	ECA1VM470B	ELECT	35V	47µF	
C1656	ECJ2VF1H104Z	ELECT	350V	100nF	
C1658	ECJ2VF1H104Z	ELECT	350V	100nF	
C1659	ECA1VM470B	ELECT	35V	47µF	
C1660	ECJ2VF1H104Z	ELECT	350V	100nF	
C1661	ECA1HM101GB	ELECT	50V	100µF	
C1662	ECJ2VF1H104Z	ELECT	350V	100nF	
C1663	ECUV1H560JCX	S.M. CAP	50V	56pF	
C1664	ECJ2VF1H104Z	ELECT	350V	100nF	
C1666	ECUV1H390JCX	S.M. CAP	50V	39pF	
C1667	ECUV1H820JCX	S.M. CAP	50V	82pF	
C1668	ECUV1H680JCX	S.M. CAP	50V	68pF	
C1669	ECUV1H271JCX	S.M. CAP	50V	270pF	
C1670	ECUV1H391JCX	S.M. CAP	50V	390pF	
C1671	ECUV1H390JCX	S.M. CAP	50V	39pF	
C1672	ECUV1H820JCX	S.M. CAP	50V	82pF	
C1673	ECUV1H680JCX	S.M. CAP	50V	68pF	
C1674	ECUV1H271JCX	S.M. CAP	50V	270pF	
C1675	ECUV1H391JCX	S.M. CAP	50V	390pF	
C1676	ECUV1H390JCX	S.M. CAP	50V	39pF	
C1677	ECUV1H820JCX	S.M. CAP	50V	82pF	
C1678	ECUV1H680JCX	S.M. CAP	50V	68pF	
C1679	ECUV1H271JCX	S.M. CAP	50V	270pF	
C1680	ECUV1H391JCX	S.M. CAP	50V	390pF	
C1681	ECUV1H820JCX	S.M. CAP	50V	82pF	
C1682	ECJ2VF1H104Z	ELECT	350V	100nF	
C1683	ECUV1H101JCX	S.M. CAP	50V	100pF	
C1685	ECJ2VF1H104Z	ELECT	350V	100nF	
C1686	ECUV1H101JCX	S.M. CAP	50V	100pF	
C1688	ECJ2VF1H104Z	ELECT	350V	100nF	
C1689	ECJ2VF1H104Z	ELECT	350V	100nF	
C1690	ECJ2VF1C105Z	ELECT	350V	1µF	
C1691	ECJ2VF1C105Z	ELECT	350V	1µF	
C1692	EEUNA1E220B	CERAMIC	25V	22µF	
C1693	ECA1HM101GB	ELECT	50V	100µF	
C1695	ECUV1H101JCX	S.M. CAP	50V	100pF	
C1696	EEUNA1E220B	CERAMIC	25V	22µF	
C1697	EEUNA1E220B	CERAMIC	25V	22µF	
C1698	EEUNA1E220B	CERAMIC	25V	22µF	
C1901	ECQM1H474J	FILM	50V	470nF	
C1902	ECQM1H474J	FILM	50V	470nF	
C1903	ECA1EM470GB	ELECT	25V	47µF	
C1904	ECJ2VF1H103Z	ELECT	350V	10nF	
C1905	ECJ2VB1C224K	ELECT	350V	220nF	
C2103	ECUV1H391KBX	S.M. CAP	50V	390pF	

Cct Ref	Parts Number	Description			
C2104	ECUV1H102KBX	S.M. CAP	50V	1nF	
C2105	ECUV1H102KBX	S.M. CAP	50V	1nF	
C2106	ECUV1H102KBX	S.M. CAP	50V	1nF	
C2107	ECUV1H102KBX	S.M. CAP	50V	1nF	
C2108	ECUV1H102KBX	S.M. CAP	50V	1nF	
C2109	ECUV1H102KBX	S.M. CAP	50V	1nF	
C2110	ECUV1H102KBX	S.M. CAP	50V	1nF	
C2111	ECA1CM100GB	ELECT	16V	10µF	
C2112	ECJ2VF1H104Z	ELECT	350V	100nF	
C2113	ECA1CM100GB	ELECT	16V	10µF	
C2114	ECA1HM101GB	ELECT	50V	100µF	
C2115	ECJ2VF1H104Z	ELECT	350V	100nF	
C2116	ECUV1H102KBX	S.M. CAP	50V	1nF	
C2117	ECUV1H471KBX	S.M. CAP	50V	470pF	
C2118	ECA1HM3R3GB	ELECT	50V	3.3µF	
C2119	ECUV1H471KBX	S.M. CAP	50V	470pF	
C2120	ECJ2VF1H104Z	ELECT	350V	100nF	
C2121	ECUV1H221JCX	S.M. CAP	50V	220pF	
C2122	ECUV1H221JCX	S.M. CAP	50V	220pF	
C2123	ECUV1H221JCX	S.M. CAP	50V	220pF	
C2124	ECJ2VF1H104Z	ELECT	350V	100nF	
C2125	ECA1CM100GB	ELECT	16V	10µF	
C2126	ECUV1H221JCX	S.M. CAP	50V	220pF	
C2127	ECJ2VF1H104Z	ELECT	350V	100nF	
C2128	ECUV1H221JCX	S.M. CAP	50V	220pF	
C2129	ECA1CM100GB	ELECT	16V	10µF	
C2130	ECUV1H221JCX	S.M. CAP	50V	220pF	
C2131	ECQM1H334J	FILM	50V	330nF	
C2132	ECA1CM100GB	ELECT	16V	10µF	
C2133	ECUV1H470JCX	S.M. CAP	50V	47pF	
C2134	ECUV1H470JCX	S.M. CAP	50V	47pF	
C2135	ECUV1H070DCX	S.M. CAP	50V	7pF	
C2137	ECJ2VF1H104Z	ELECT	350V	100nF	
C2138	ECUV1H010CCX	S.M. CAP	50V	1pF	
C2139	ECUV1H010CCX	S.M. CAP	50V	1pF	
C2141	ECUV1H560JCX	S.M. CAP	50V	56pF	
C2142	ECA1CM100GB	ELECT	16V	10µF	
C2144	ECUV1H560JCX	S.M. CAP	50V	56pF	
C2146	ECA1CM100GB	ELECT	16V	10µF	
C2147	ECUV1H103KBX	S.M. CAP	50V	10nF	
C2148	ECUV1H103KBX	S.M. CAP	50V	10nF	
C2301	ECA1CM470GB	ELECT	16V	47µF	
C2302	ECA1CM470GB	ELECT	16V	47µF	
C2307	ECUV1H103KBX	S.M. CAP	50V	10nF	
C2308	ECUV1H103KBX	S.M. CAP	50V	10nF	
C2353	ECA1CM471GB	ELECT	16V	470µF	
C2356	ECA1HM4R7GB	ELECT	50V	4.7µF	
C2357	ECUV1H151JCX	S.M. CAP	50V	150pF	
C2358	ECUV1H151JCX	S.M. CAP	50V	150pF	
C2359	ECA1HM4R7GB	ELECT	50V	4.7µF	
C2361	ECA1CM470GB	ELECT	16V	47µF	
C2362	ECA1HM101GB	ELECT	50V	100µF	
C2363	ECEA1HU221	ELECT	50V	100µF	
C2364	ECEA1HU221	ELECT	50V	100µF	
C2365	ECA1HM101GB	ELECT	50V	100µF	
C2366	ECA0JM222GB	ELECT	6.3V	2.2nF	
C2367	ECJ2VF1H104Z	ELECT	350V	100nF	
C2370	ECA1HM100GB	ELECT	50V	10µF	
C2371	ECUV1H472KBX	S.M. CAP	50V	4.7nF	
C2372	ECUV1H472KBX	S.M. CAP	50V	4.7nF	
C2375	ECJ2VF1H104Z	ELECT	350V	100nF	
C2377	ECUV1H102JCX	S.M. CAP	50V	1nF	
C2378	ECUV1H102JCX	S.M. CAP	50V	1nF	
C2381	ECKC1H103JB	CERAMIC	50V	10nF	
C2382	ECKC1H103JB	CERAMIC	50V	10nF	
C2430	ECUV1H561JCX	S.M. CAP	50V	560pF	

Cct Ref	Parts Number	Description		
C2431	ECUV1H561JCX	S.M. CAP	50V	560pF
C2437	ECUV1H561JCX	S.M. CAP	50V	560pF
C2438	ECUV1H561JCX	S.M. CAP	50V	560pF
C3002	ECA1CM470GB	ELECT	16V	47µF
C3003	ECUV1H102ZFX	S.M. CAP	50V	1nF
C3004	ECJ2VF1H104Z	ELECT	350V	100nF
C3005	ECJ2VF1H104Z	ELECT	350V	100nF
C3006	ECA1HM4R7GB	ELECT	50V	4.7µF
C3007	ECA1HM4R7GB	ELECT	50V	4.7µF
C3008	ECJ2VF1H104Z	ELECT	350V	100nF
C3009	ECUV1H473ZFX	S.M. CAP	50V	47nF
C3010	ECUV1H680JCX	S.M. CAP	50V	68pF
C3011	ECA1CM221GB	ELECT	16V	220µF
C3012	ECA1CM470GB	ELECT	16V	47µF
C3013	ECA1CM470GB	ELECT	16V	47µF
C3014	EEUNA1A470B	CERAMIC	10V	47µF
C3015	ECJ2VF1H104Z	ELECT	350V	100nF
C3016	ECA1CM470GB	ELECT	16V	47µF
C3017	ECJ2VF1H104Z	ELECT	350V	100nF
C3018	ECJ2VF1H104Z	ELECT	350V	100nF
C3021	ECA1CM331B	ELECT	16V	330µF
C3022	ECA1CM102B	ELECT	16V	330µF
C3023	ECA1HM100GB	ELECT	50V	10µF
C3024	ECA1HM2R2GB	ELECT	50V	2.2µF
C3025	ECA1CM470GB	ELECT	16V	47µF
C3026	ECUV1H224ZFX	S.M. CAP	50V	220nF
C3027	ECJ2VF1H104Z	ELECT	350V	100nF
C3028	ECUV1H470JRX	S.M. CAP	50V	100nF
C3120	ECUV1H103KBX	S.M. CAP	50V	10nF
C3122	ECUV1H102KBX	S.M. CAP	50V	1nF
C3123	ECUV1H103KBX	S.M. CAP	50V	10nF
C3124	ECUV1H102KBX	S.M. CAP	50V	1nF
C3255	ECA1HM4R7GB	ELECT	50V	4.7µF
C3256	ECA1HM4R7GB	ELECT	50V	4.7µF
C3282	ECKC1H561J	CERAMIC	50V	560pF
C3284	ECKC1H561J	CERAMIC	50V	560pF
C3351	ECA1CM221GB	ELECT	16V	220µF
C3401	ECEA1HKA100	ELECT	50V	220µF
C3402	ECUV1H561JCX	S.M. CAP	50V	560pF
C3403	ECUV1H561JCX	S.M. CAP	50V	560pF
C3404	ECUV1H561JCX	S.M. CAP	50V	560pF
C3405	ECUV1H561JCX	S.M. CAP	50V	560pF
C3406	ECUV1H561JCX	S.M. CAP	50V	560pF
C3407	ECUV1H561JCX	S.M. CAP	50V	560pF
C3408	ECUV1H561JCX	S.M. CAP	50V	560pF
C3409	ECEA1HKA4R7	ELECT	50V	560pF
C3410	ECEA1HKA100	ELECT	50V	560pF
C3411	ECUV1H561JCX	S.M. CAP	50V	560pF
C3412	ECEA1HKA4R7	ELECT	50V	560pF
C3413	ECUV1H102JCX	S.M. CAP	50V	1nF
C3414	ECEA1HKA100	ELECT	50V	1nF
C3415	ECEA1HKA100	ELECT	50V	1nF
C3416	ECEA1HKA4R7	ELECT	50V	1nF
C3417	ECEA1HKA100	ELECT	50V	1nF
C3418	ECEA1HKA100	ELECT	50V	1nF
C3419	ECUV1H561JCX	S.M. CAP	50V	560pF
C3420	ECUV1H561JCX	S.M. CAP	50V	560pF
C3421	ECUV1H561JCX	S.M. CAP	50V	560pF
C3422	ECUV1H561JCX	S.M. CAP	50V	560pF
C3423	ECUV1H561JCX	S.M. CAP	50V	560pF
C3424	ECUV1H561JCX	S.M. CAP	50V	560pF
C3425	ECUV1H561JCX	S.M. CAP	50V	560pF
C3426	ECUV1H561JCX	S.M. CAP	50V	560pF
C3427	ECUV1H102JCX	S.M. CAP	50V	1nF
C3428	ECEA1HKA4R7	ELECT	50V	1nF
C3429	ECEA1CKA220	ELECT	16V	1nF

Cct Ref	Parts Number	Description		
C3430	ECEA1HKA4R7	ELECT	50V	1nF
C3431	ECEA1CN470	ELECT	16V	47µF
C3432	ECUV1H104ZFX	S.M. CAP	50V	100nF
C3433	ECA1CM221GB	ELECT	16V	220µF
C3460	ECUV1H561JCX	S.M. CAP	50V	560pF
C3461	ECUV1H561JCX	S.M. CAP	50V	560pF
C3496	ECUV1H561JCX	S.M. CAP	50V	560pF
C3497	ECUV1H561JCX	S.M. CAP	50V	560pF
C3498	ECUV1H561JCX	S.M. CAP	50V	560pF
C3802	ECA1CM100GB	ELECT	16V	10µF
C3803	ECA1EM100GB	ELECT	25V	0.1µF
C3804	ECJ2VF1H104Z	ELECT	350V	100nF
C3805	ECUV1H224ZFX	S.M. CAP	50V	220nF
C3806	ECA1HM101GB	ELECT	50V	100µF
C3807	ECA1HM100GB	ELECT	50V	10µF
C3808	ECA1CM470GB	ELECT	16V	47µF
C3814	ECA1HM010GB	ELECT	50V	1µF
C3816	ECA1CM471GB	ELECT	16V	470µF
C3817	ECA1CM221GB	ELECT	16V	220µF
C3818	ECUV1H103KBX	S.M. CAP	50V	10nF
C3819	ECA1HM010GB	ELECT	50V	1µF
C3821	ECA1HM010GB	ELECT	50V	1µF
C3823	ECJ2VF1H104Z	ELECT	350V	100nF
C3824	ECUV1H103KBX	S.M. CAP	50V	10nF
C3825	ECJ2VB1C224K	ELECT	350V	220nF
C3826	ECUV1H103KBX	S.M. CAP	50V	10nF
C3827	ECUV1H224ZFX	S.M. CAP	50V	220nF
TERMINALS AND LINKS				
JK3401	1364-21-21	SCART SOCKET		
JK3402	1364-21-21	SCART SOCKET		
JK2403	TJB8E014	RCA TERMINAL (2P)		
JK3281	TJB8E026	AV TERMINAL		
R847	TSF19252	FS LINK		▲
R848	TSF19402	FS LINK		▲
R1914	TSF19161	FS LINK		▲
SWITCHES				
S840	ESB92S11B	SWITCH		▲
S1071	EVQ23405R	SWITCH		
S1072	EVQ23405R	SWITCH		
S1073	EVQ23405R	SWITCH		
S1074	EVQ23405R	SWITCH		
S1075	EVQ23405R	SWITCH		

SCHEMA ELETTRICO TX-32DK10F (TELAIO EURO-5)

IMPORTANTI INFORMAZIONI DI SICUREZZA

I componenti indicati con  hanno caratteristiche speciali ed importante per la sicurezza. Qualora tali componenti vengano sostituiti, devono essere usati solo quelli specificati dal costruttore.

Nota

1. RESISTENZE

Tutte le resistenze sono al carbone da 1/8W se sono contrassegnate come segue :
I valori sono espressi in OHM Ω k=1,000 M=1,000,000.

2. CONDENSATORI

Tutti i condensatori sono ceramici 50V, se non sono contrassegnati come segue :
I valori sono espressi in μ F, se non diversamente specificato.

3. BOBINE

I valori sono espressi in μ H, se non diversamente specificato.
Il contrassegno "L" sullo schema elettrico indica la polarità.

4. TEST POINT

 Posizione dei test point

5. MASSA

 Massa Linea (Caldo)

 Massa Telaio (Freddo)

6. CONTROLLI DI TENSIONE

Le tensioni sono misurate con voltmetro d.c. alle seguenti condizioni :

Alimentazione	a.c. 220-240V, 50Hz
Segnale ricevuto	Segnale a barre colori in (RF)
Controlli dell'utente	Massime regolazioni

7. Indica il flusso di segnale principale.

 VIDEO

 AUDIO

8. Questo schema elettrico è soggetto a variazioni senza preavviso.

Precauzioni

- Nell'intento di prevenire possibili scosse elettriche evitare di toccare le zone fredde e calde.
- Un corto circuito fra le due sezioni può provocare anomalie nei componenti.
- Nell'utilizzo di uno strumento di misura la massa dello stesso deve essere collegata alla massa del circuito da misurare.
- Le resistenze sotto indicate sono componenti fusibili di sicurezza, e risultano differenziati per valori di corrente.

Nota

- Nel circuito di alimentazione è presente una sezione le cui tensioni risultano separate dalla massa generale del telaio. Sullo schema elettrico vengono definite aree calda e fredda. Prestare particolare attenzione. Tutti i circuiti escludono quella di alimentazione sono freddi.

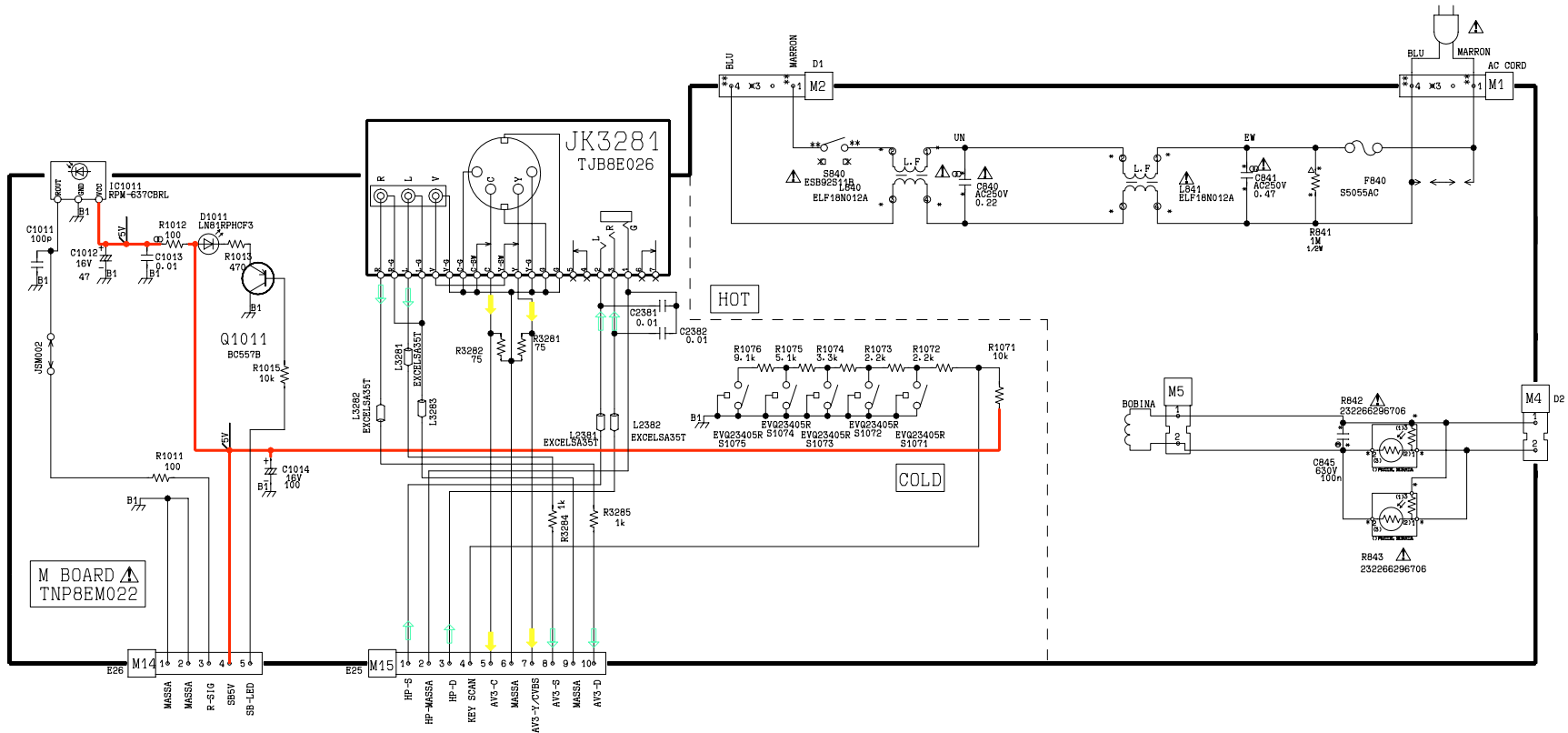

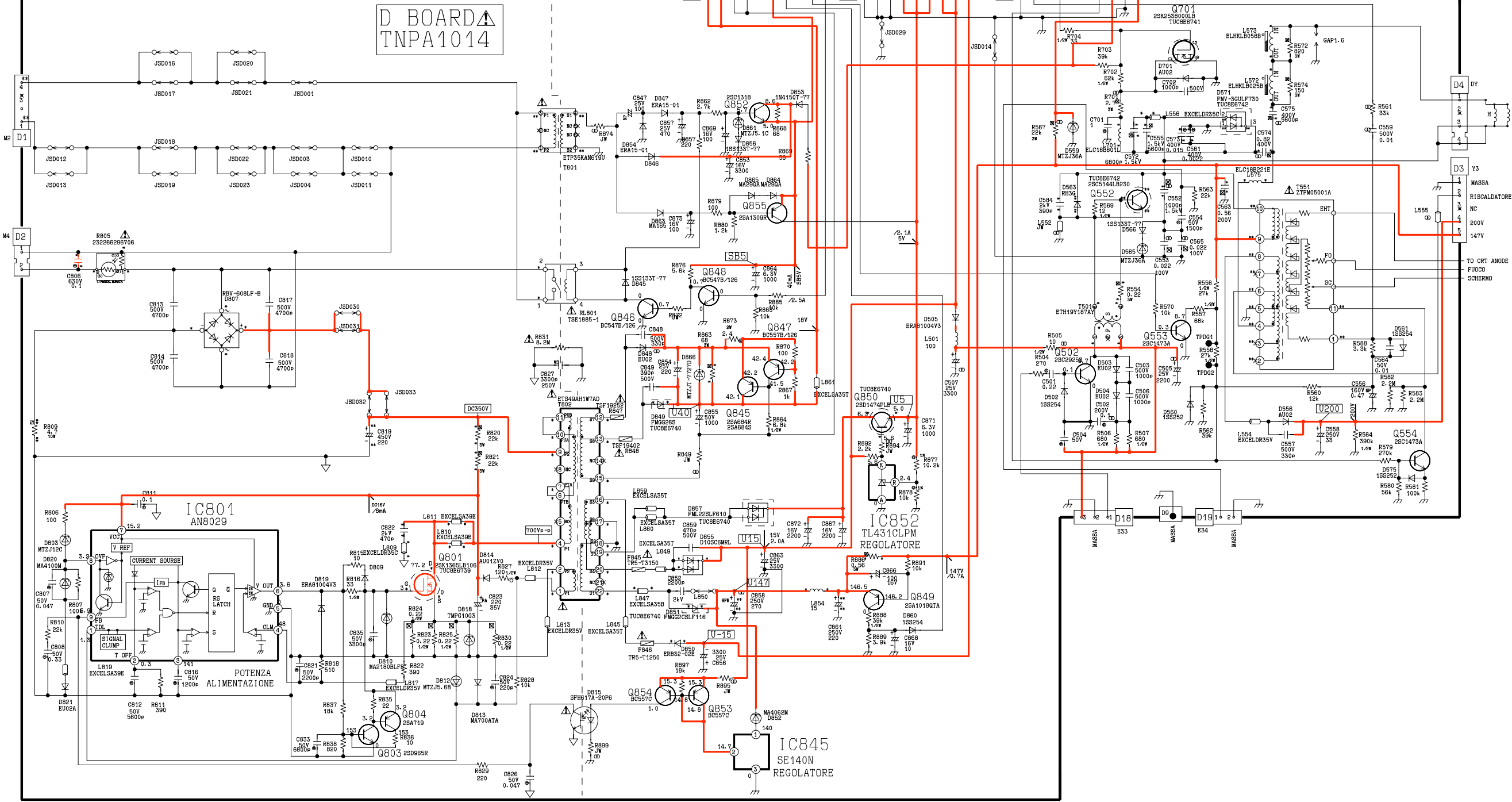

D BOARD
TNPA1014

IC801
AN8029

IC852
TL431CLPM
REGOLATORE

IC845
SE140N
REGOLATORE

D4
DY

D3
Y3

MASSA
RISCALDATORE

NC
200V

147V

TO CRT ANODE
FUOCO
SCHERMO

H BOARD
TNPA1047

AV1
JK3401

AV2
JK3402

JK2403
TJB8E014

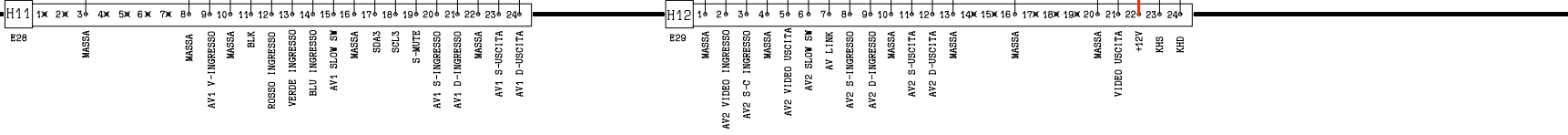
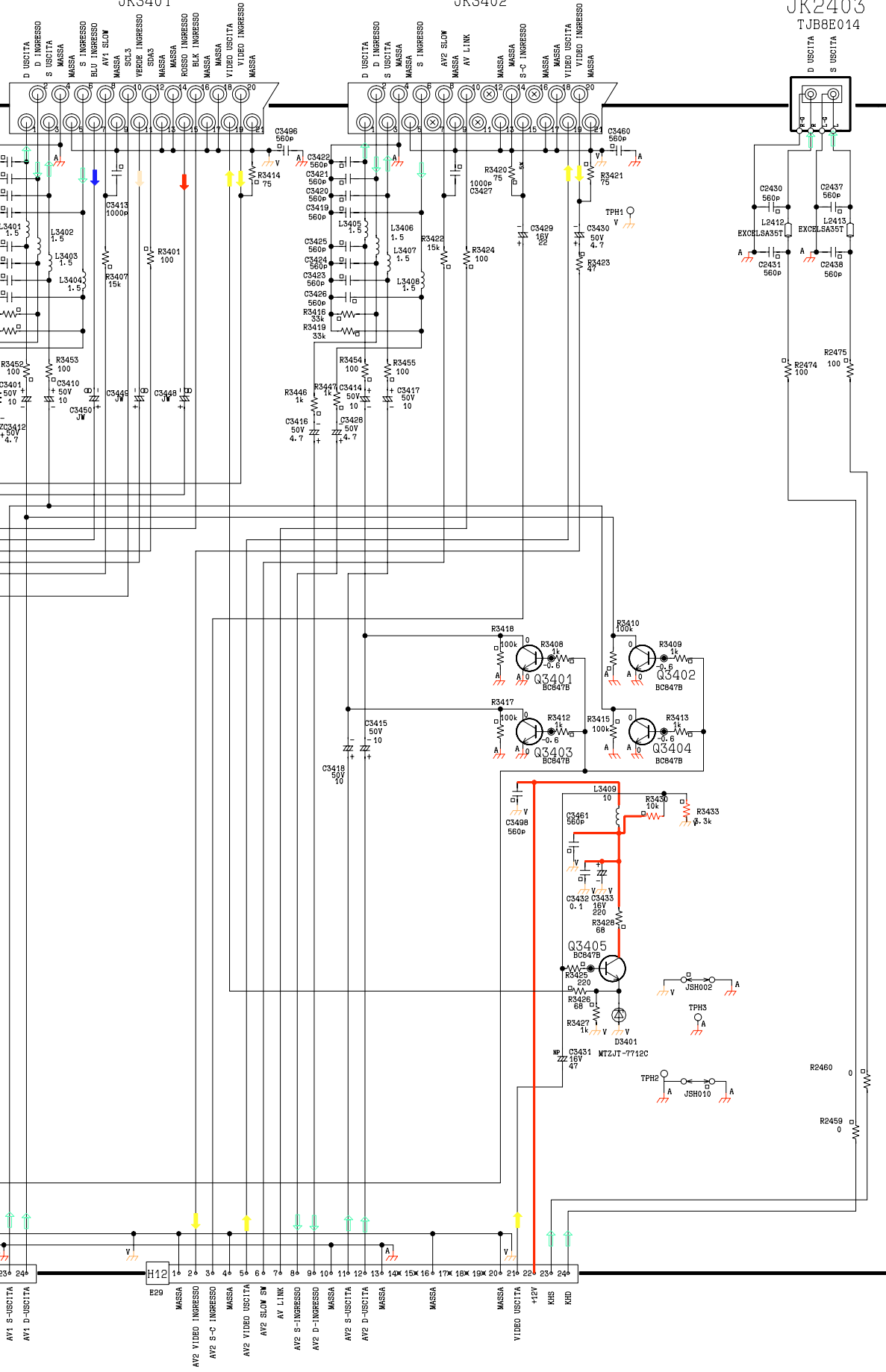

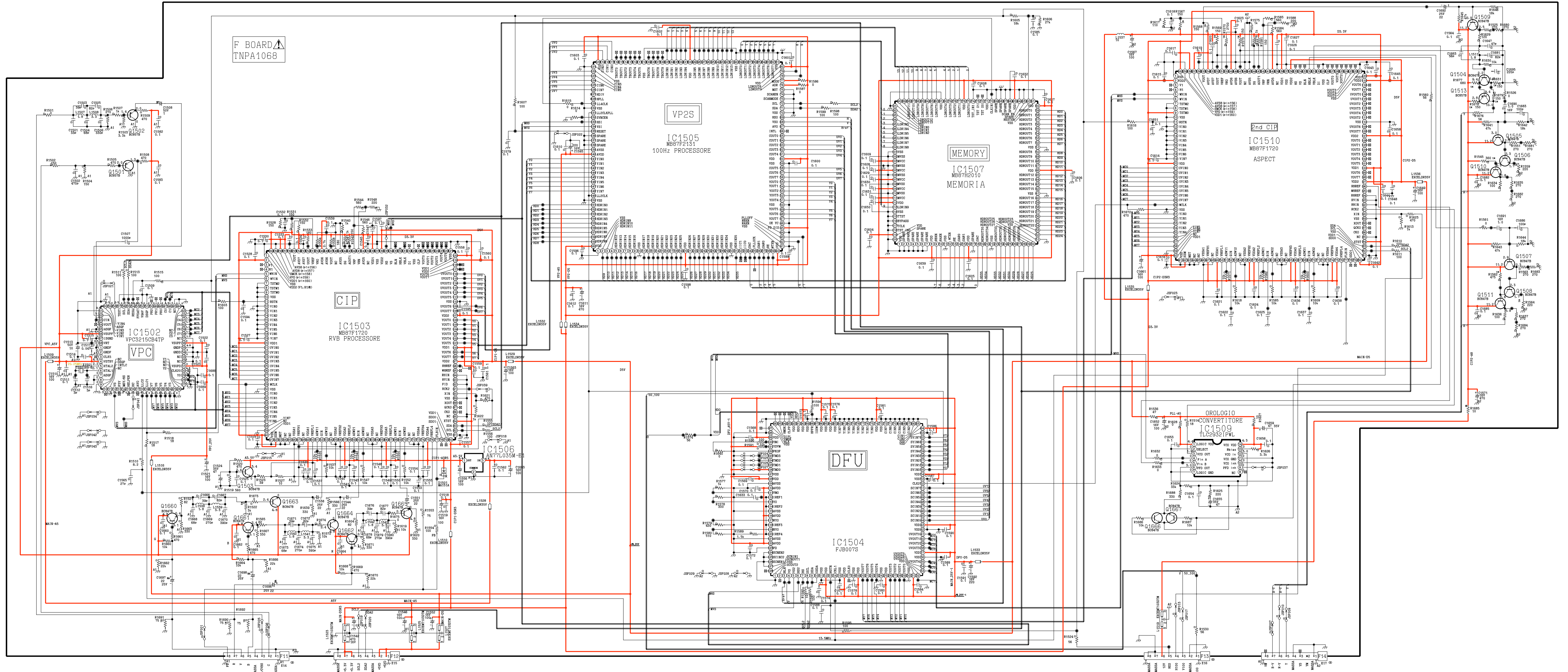

Y BOARD
TNPA1353

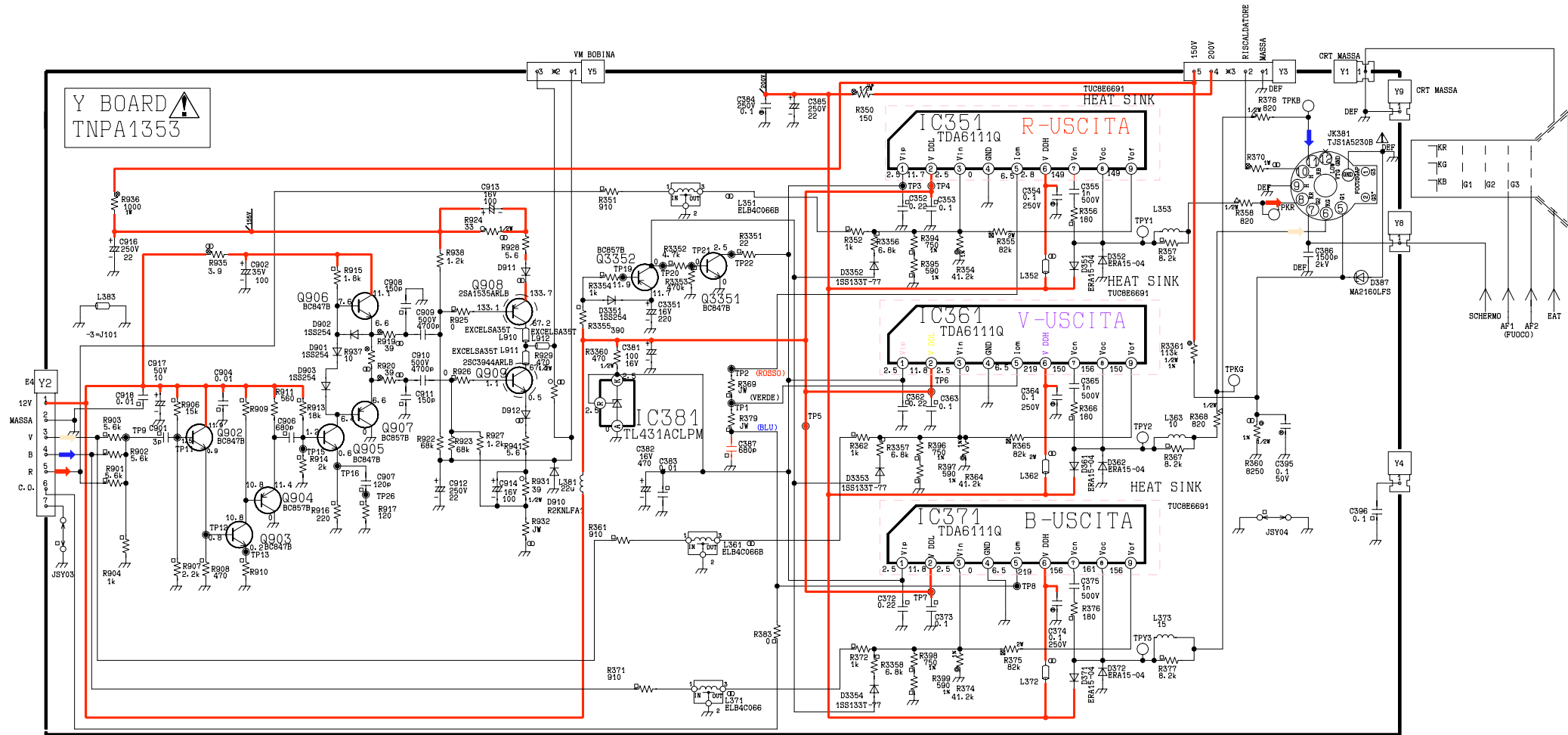

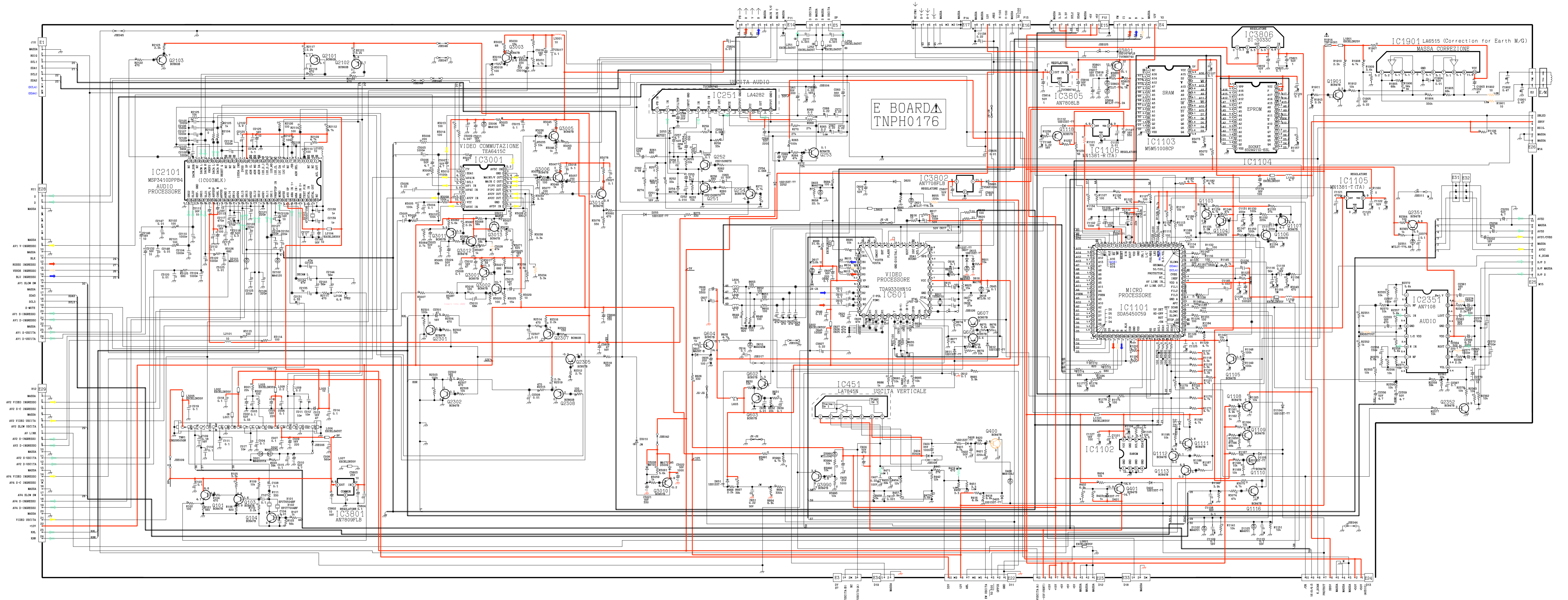

E BOARD
TNP0176

REGOLATORE
IC3806
SI-3033C

REGOLATORE
IC1901 LA6515 (Correction for Earth M/G)
MASSA CORREZIONE

REGOLATORE
IC1105
MN1381-T (TA)

REGOLATORE
IC3805
AN7808LB

REGOLATORE
IC4106
MN1381-T (TA)

REGOLATORE
IC3802
AN7708FLB

MICRO
PROCESSORE
IC1101
SDA5450C59

IC451
LA7845N - USCITA VERTICALE

REGOLATORE
IC2351
AN7108

IC2101
MSP3410DPPB4
AUDIO
PROCESSORE

VIDEO
COMMUTAZIONE
IC3001
TEA6415C

VIDEO
PROCESSORE
IC601
TDA9330HN1G

IC1103
MMS1008CP
SRAM

IC1104
MMS1008CP
EPROM

IC3002
TEA6415C

IC3003
TEA6415C

IC3004
TEA6415C

IC3005
TEA6415C

IC3006
TEA6415C

IC3007
TEA6415C

IC3008
TEA6415C

IC3009
TEA6415C

IC3010
TEA6415C

IC3011
TEA6415C

IC3012
TEA6415C

IC3013
TEA6415C

IC3014
TEA6415C

IC3015
TEA6415C

IC3016
TEA6415C

IC3017
TEA6415C

IC3018
TEA6415C

IC3019
TEA6415C

IC3020
TEA6415C

IC3021
TEA6415C

IC3022
TEA6415C

IC3023
TEA6415C

IC3024
TEA6415C

IC3025
TEA6415C

IC3026
TEA6415C

IC3027
TEA6415C

IC3028
TEA6415C

IC3029
TEA6415C

IC3030
TEA6415C

IC3031
TEA6415C

IC3032
TEA6415C

IC3033
TEA6415C

IC3034
TEA6415C

IC3035
TEA6415C

IC3036
TEA6415C

IC3037
TEA6415C

IC3038
TEA6415C

IC3039
TEA6415C

IC3040
TEA6415C

IC3041
TEA6415C

IC3042
TEA6415C

IC3043
TEA6415C

IC3044
TEA6415C

IC3045
TEA6415C

IC3046
TEA6415C

IC3047
TEA6415C

IC3048
TEA6415C

IC3049
TEA6415C

IC3050
TEA6415C

IC3051
TEA6415C

IC3052
TEA6415C

IC3053
TEA6415C

IC3054
TEA6415C

IC3055
TEA6415C

IC3056
TEA6415C

IC3057
TEA6415C

IC3058
TEA6415C

IC3059
TEA6415C

IC3060
TEA6415C

IC3061
TEA6415C

IC3062
TEA6415C

IC3063
TEA6415C

IC3064
TEA6415C

IC3065
TEA6415C

IC3066
TEA6415C

IC3067
TEA6415C

IC3068
TEA6415C

IC3069
TEA6415C

IC3070
TEA6415C

IC3071
TEA6415C

IC3072
TEA6415C

IC3073
TEA6415C

IC3074
TEA6415C

IC3075
TEA6415C

IC3076
TEA6415C

IC3077
TEA6415C

IC3078
TEA6415C

IC3079
TEA6415C

IC3080
TEA6415C

IC3081
TEA6415C

IC3082
TEA6415C

IC3083
TEA6415C

IC3084
TEA6415C

IC3085
TEA6415C

IC3086
TEA6415C

IC3087
TEA6415C

IC3088
TEA6415C

IC3089
TEA6415C

IC3090
TEA6415C

IC3091
TEA6415C

IC3092
TEA6415C

IC3093
TEA6415C

IC3094
TEA6415C

IC3095
TEA6415C

IC3096
TEA6415C

IC3097
TEA6415C

IC3098
TEA6415C

IC3099
TEA6415C

IC3100
TEA6415C

IC3101
TEA6415C

IC3102
TEA6415C

IC3103
TEA6415C

IC3104
TEA6415C

IC3105
TEA6415C

IC3106
TEA6415C

IC3107
TEA6415C

IC3108
TEA6415C

IC3109
TEA6415C

IC3110
TEA6415C

IC3111
TEA6415C

IC3112
TEA6415C

IC3113
TEA6415C

IC3114
TEA6415C

IC3115
TEA6415C

IC3116
TEA6415C

IC3117
TEA6415C

IC3118
TEA6415C

IC3119
TEA6415C

IC3120
TEA6415C

IC3121
TEA6415C

IC3122
TEA6415C

IC3123
TEA6415C

IC3124
TEA6415C

IC3125
TEA6415C

IC3126
TEA6415C

IC3127
TEA6415C

IC3128
TEA6415C

IC3129
TEA6415C

IC3130
TEA6415C

IC3131
TEA6415C

IC3132
TEA6415C

IC3133
TEA6415C

IC3134
TEA6415C

IC3135
TEA6415C

IC3136
TEA6415C

IC3137
TEA6415C

IC3138
TEA6415C

IC3139
TEA6415C

IC3140
TEA6415C

IC3141
TEA6415C

IC3142
TEA6415C

IC3143
TEA6415C

IC3144
TEA6415C

IC3145
TEA6415C

IC3146
TEA6415C

IC3147
TEA6415C

IC3148
TEA6415C

IC3149
TEA6415C

IC3150
TEA6415C

IC3151
TEA6415C

IC3152
TEA6415C

IC3153
TEA6415C

IC3154
TEA6415C

IC3155
TEA6415C

IC3156
TEA6415C

IC3157
TEA6415C

IC3158
TEA6415C

IC3159
TEA6415C

IC3160
TEA6415C

IC3161
TEA6415C

IC3162
TEA6415C

IC3163
TEA6415C

IC3164
TEA6415C

IC3165
TEA6415C

IC3166
TEA6415C

IC3167
TEA6415C

IC3168
TEA6415C

IC3169
TEA6415C

IC3170
TEA6415C

IC3171
TEA6415C

IC3172
TEA6415C

IC3173
TEA6415C

IC3174
TEA6415C

IC3175
TEA6415C

IC3176
TEA6415C

IC3177
TEA6415C

IC3178
TEA6415C

IC3179
TEA6415C

IC3180
TEA6415C

IC3181
TEA6415C

IC3182
TEA6415C

IC3183
TEA6415C

IC3184
TEA6415C

IC3185
TEA6415C

IC3186
TEA6415C

IC3187
TEA6415C

IC3188
TEA6415C

IC3189
TEA6415C

IC3190
TEA6415C

IC3191
TEA6415C

IC3192
TEA6415C

IC3193
TEA6415C

IC3194
TEA6415C

IC3195
TEA6415C

IC3196
TEA6415C

IC3197
TEA6415C

IC3198
TEA6415C

IC3199
TEA6415C

IC3200
TEA6415C

IC3201
TEA6415C

IC3202
TEA6415C

IC3203
TEA6415C

IC3204
TEA6415C

IC3205
TEA6415C

IC3206
TEA6415C

IC3207
TEA6415C

IC3208
TEA6415C

IC3209
TEA6415C

IC3210
TEA6415C

IC3211
TEA6415C

IC3212
TEA6415C

IC3213
TEA6415C

IC3214
TEA6415C

IC3215
TEA6415C

IC3216
TEA6415C

IC3217
TEA6415C

IC3218
TEA6415C

IC3219
TEA6415C

SCHEDA - Y TNPA1353

TRAN'S	
Q901	C1
Q902	B1
Q903	B1
Q904	B1
Q906	C1
Q908	D1
Q909	D1
Q3351	A2
Q3352	A2
DIODE'S	
D351	B3
D352	B3
D361	A2
D362	A2
D371	C3
D372	C2
D373	C3
D374	A1
D375	B2
D387	B1
D901	C1
D902	C1
D903	C1
D910	C1
D911	D2
D3351	A2
D3352	A3
D3353	A1
D3354	C3
T.P.'S	
TPY1	B3
TPY2	A2
TPY3	C2
TPKR	B3
TPKB	B2
TPKB	C2
I.C.'S	
IC351	B2
IC361	A1
IC371	C3
IC381	C3

A
B
C
D

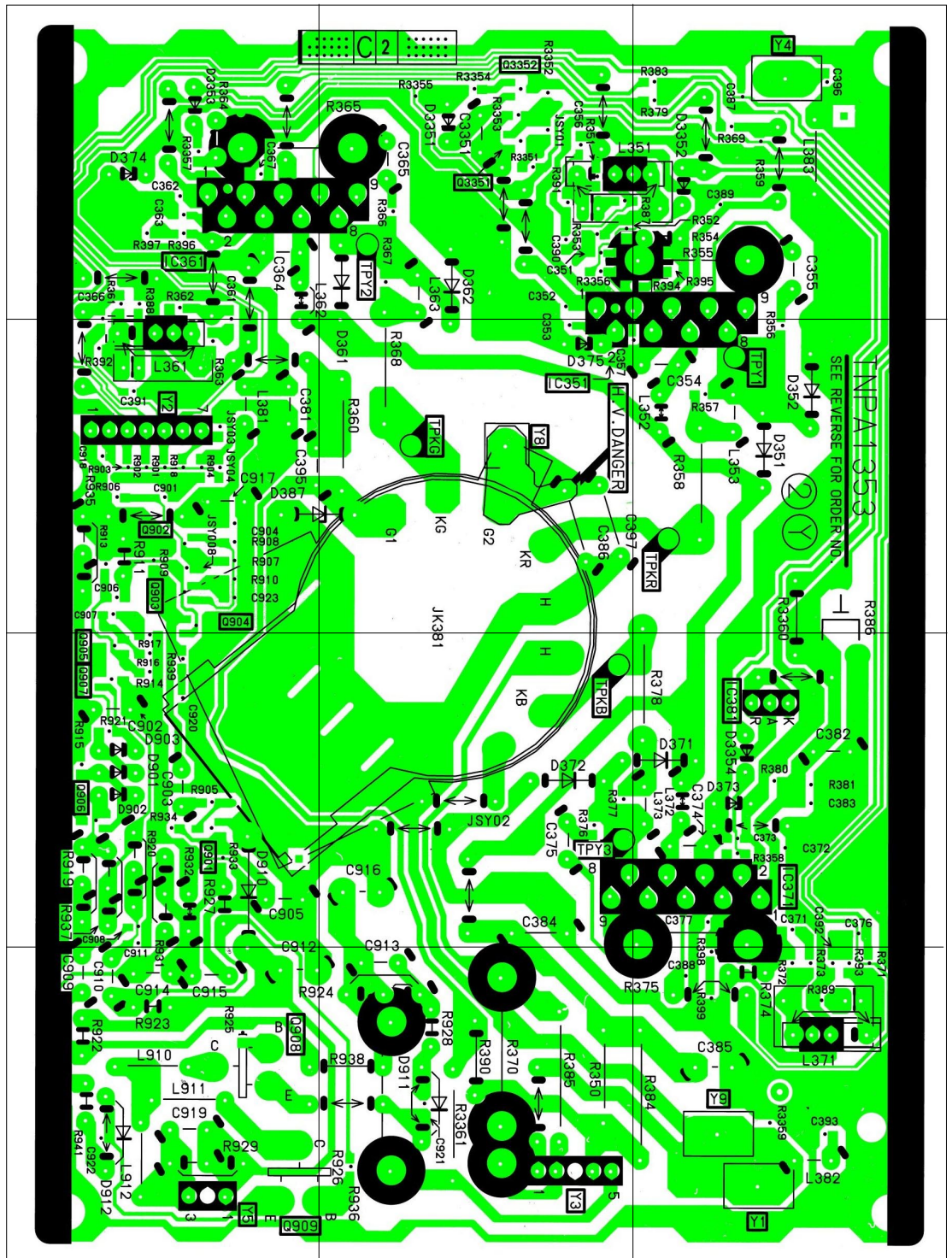

1 2 3

VISTA LATO COMPONENTI

SCHEDA - E TNPH0176

TRAN'S		DIODE'S			
Q101	A3	D001	A1	D2364	A6
Q103	A3	D002	A1	D3005	B1
Q104	A3	D252	E5	D3006	B2
Q251	D4	D253	E5	D3008	B4
Q252	D4	D254	E5	D3009	A3
Q253	E4	D255	E4	D3010	A3
Q254	E4	D256	E4	D3011	B1
Q281	E3	D281	E4	D3803	A5
Q282	D3	D282	E4	D3804	A5
Q400	B5	D283	E4	D3805	C5
Q401	A4	D284	E2	D3990	A4
Q601	B5	D285	E3		
Q602	B4	D286	E2		
Q603	C4	D400	B5	I.C.'S	
Q604	C4	D401	A4	IC251	E4
Q607	C4	D402	A4	IC281	E2
Q608	D4	D403	B4	IC451	A4
Q1001	C7	D404	A4	IC1001	C7
Q1105	C6	D405	A6	IC1101	D5
Q1106	C6	D408	B5	IC1102	E5
Q1107	C6	D411	A4	IC1103	E5
Q1108	A5	D601	B4	IC1104	D5
Q1109	A5	D603	D5	IC1105	B6
Q1110	A5	D605	B5	IC1106	D6
Q1111	C5	D607	B5	IC1901	C6
Q1112	E5	D609	B5	IC2101	B3
Q1113	E5	D610	C4	IC2351	A6
Q1114	C6	D611	C4	IC3001	B1
Q1116	C6	D612	C4	IC3801	A2
Q1118	D6	D615	B5	IC3802	C5
Q1901	C6	D616	B5	IC3805	B5
Q2101	B2	D617	D5	IC3806	D1
Q2102	C2	D618	C4		
Q2103	B2	D620	B5	T.P.'S	
Q2301	B2	D651	C4	TPE1	A2
Q2302	A2	D652	C4	TPE2	B3
Q2305	A2	D653	B4	TPE23	D6
Q2307	A3	D1001	C7		
Q2308	A3	D1101	C1		
Q2351	A6	D1102	C1		
Q2352	A6	D1103	C1		
Q3001	C1	D1104	A6		
Q3002	B1	D1105	A6		
Q3003	B2	D1106	B6		
Q3005	D1	D1107	C5		
Q3006	D1	D1108	C6		
Q3007	D1	D1109	D6		
Q3008	D1	D1110	D6		
Q3010	A3	D1111	D6		
Q3011	B2	D1112	D6		
Q3012	B2	D2101	B2		
Q3013	B2	D2102	B2		
Q3014	D1	D2301	A2		
Q3801	A5	D2302	A2		
Q3990	A4	D2351	A6		

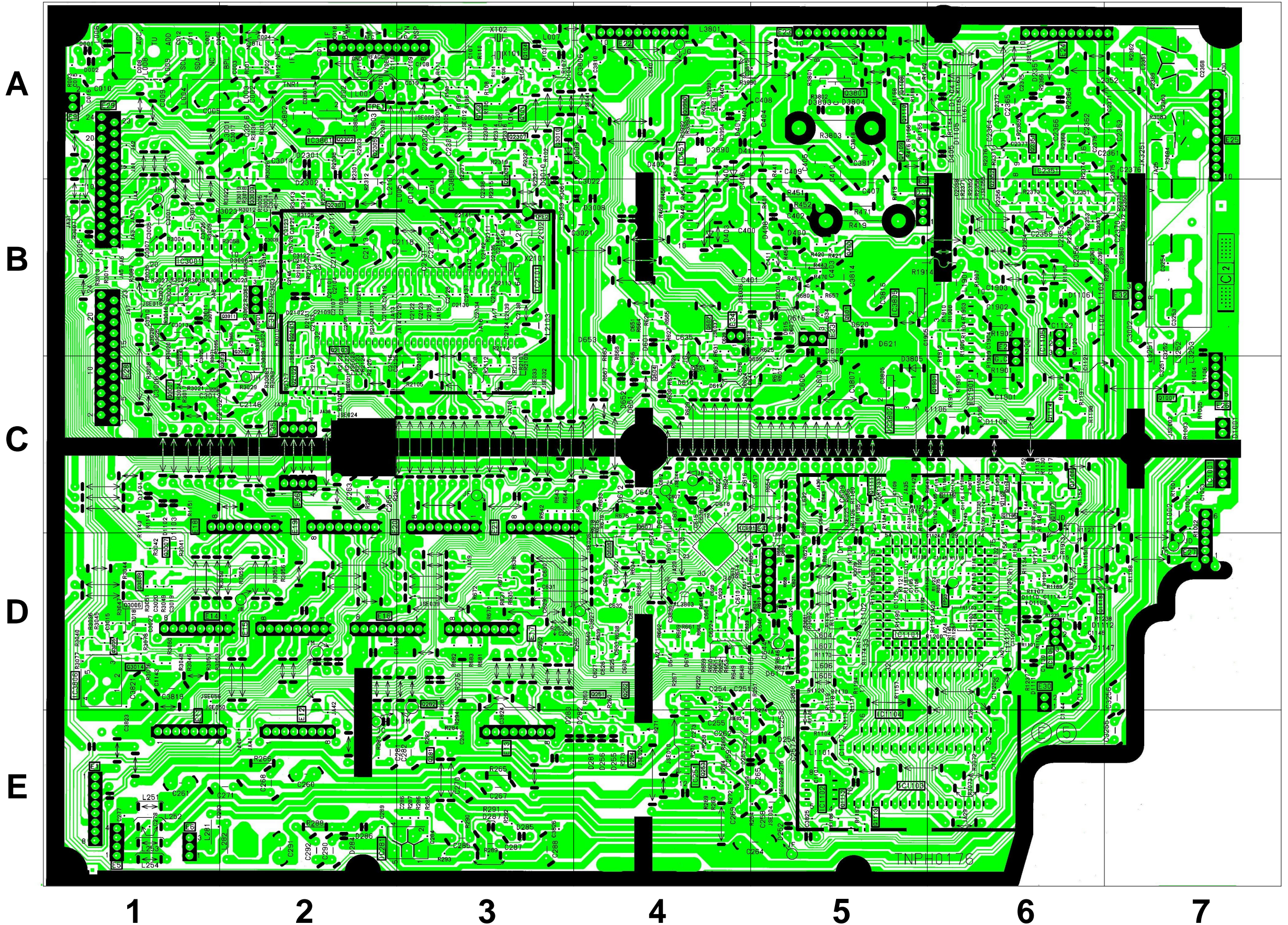

SCHEDA - D TNPA1014

DIODE'S	D853	E7	
D503	A4	D854	E6
D504	A3	D855	E3
D505	C3	D856	E7
D551	A4	D857	E3
D556	C1	D858	E5
D559	E3	D860	E1
D560	D1	D861	E7
D561	D1	D863	D7
D563	A3	D864	D7
D565	A1		
D566	A1	TRAN'S	
D571	A2	Q502	A4
D575	C1	Q552	A3
D701	E2	Q553	D1
D702	E2	Q554	C1
D803	C4	Q701	E1
D807	B6	Q801	B5
D808	B4	Q803	B4
D809	B4	Q804	B4
D810	B4	Q845	E6
D812	B4	Q846	D7
D813	B4	Q847	E6
D814	C4	Q848	D7
D815	C3	Q849	E1
D817	C6	Q850	E2
D818	B4	Q852	E7
D819	C4	Q853	D3
D820	C4	Q854	D3
D821	C4		
D845	D7	I.C.'S	
D846	E7	IC801	B4
D847	E6	IC845	D3
D848	E6	IC852	E2
D849	E5		
D850	E4	T.P.'S	
D851	D3	TPDG1	D1
D852	D3	TPDG2	D1

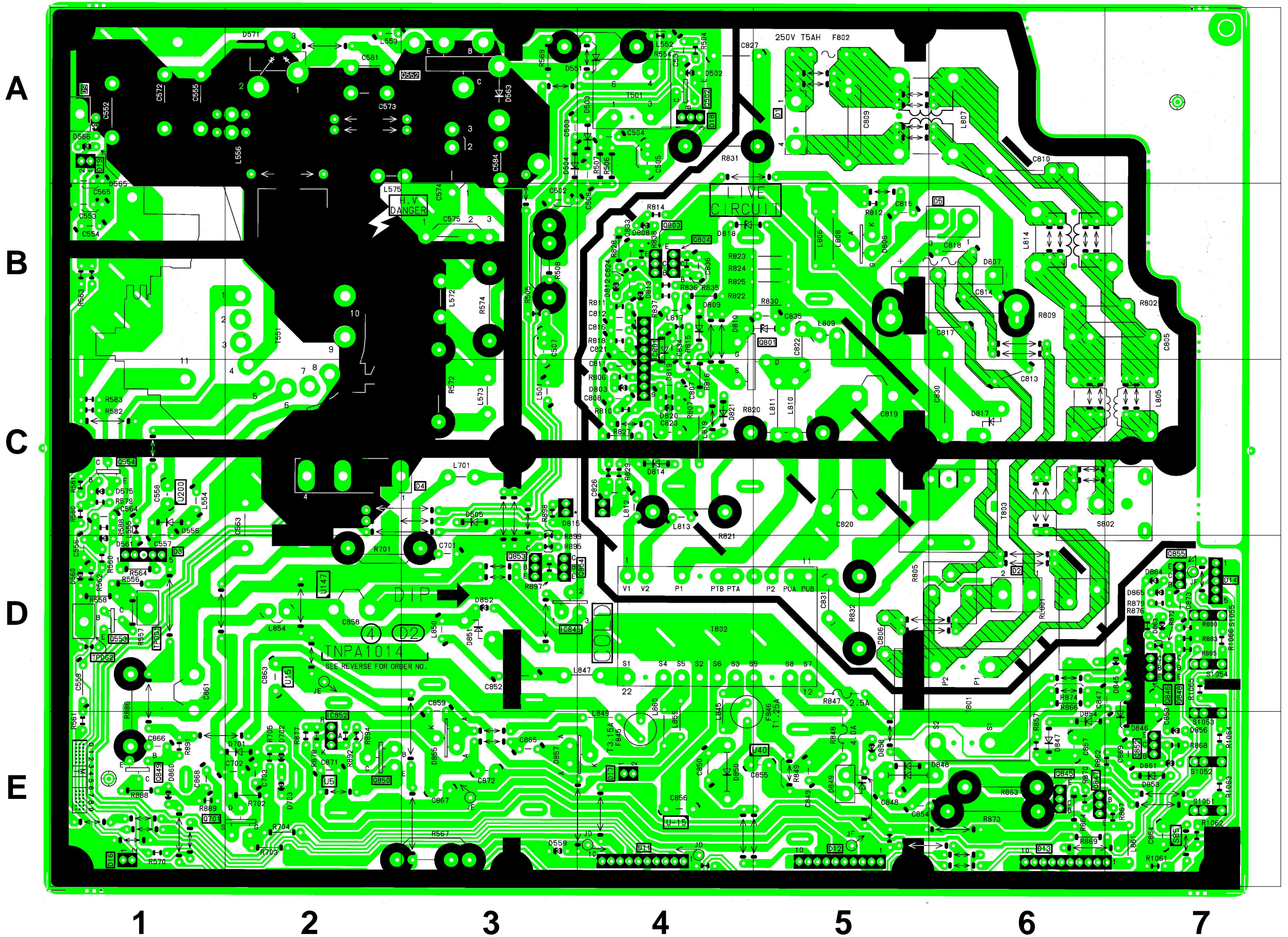

SCHEDA - H TNPA1047

TRAN'S	
Q2401	A2
Q2407	A3
Q2408	A3
Q2409	A3
Q2410	A3
Q2411	A3
Q2412	A3
Q3401	B1
Q3402	C1
Q3403	B1
Q3404	C1
Q3405	C3
Q3406	C3

DIODE'S	
D2401	A2
D2403	A3
D2404	A3
D2405	A3
D2406	A3
D2407	A3
D2408	A3
D3401	C3
D3402	C3

T.P.'S	
TPH1	D1
TPH2	A2
TPH3	D1
TPH004	D1
TPH005	D1

I.C.'S	
IC2401	A2
IC2402	A3

A

B

C

D

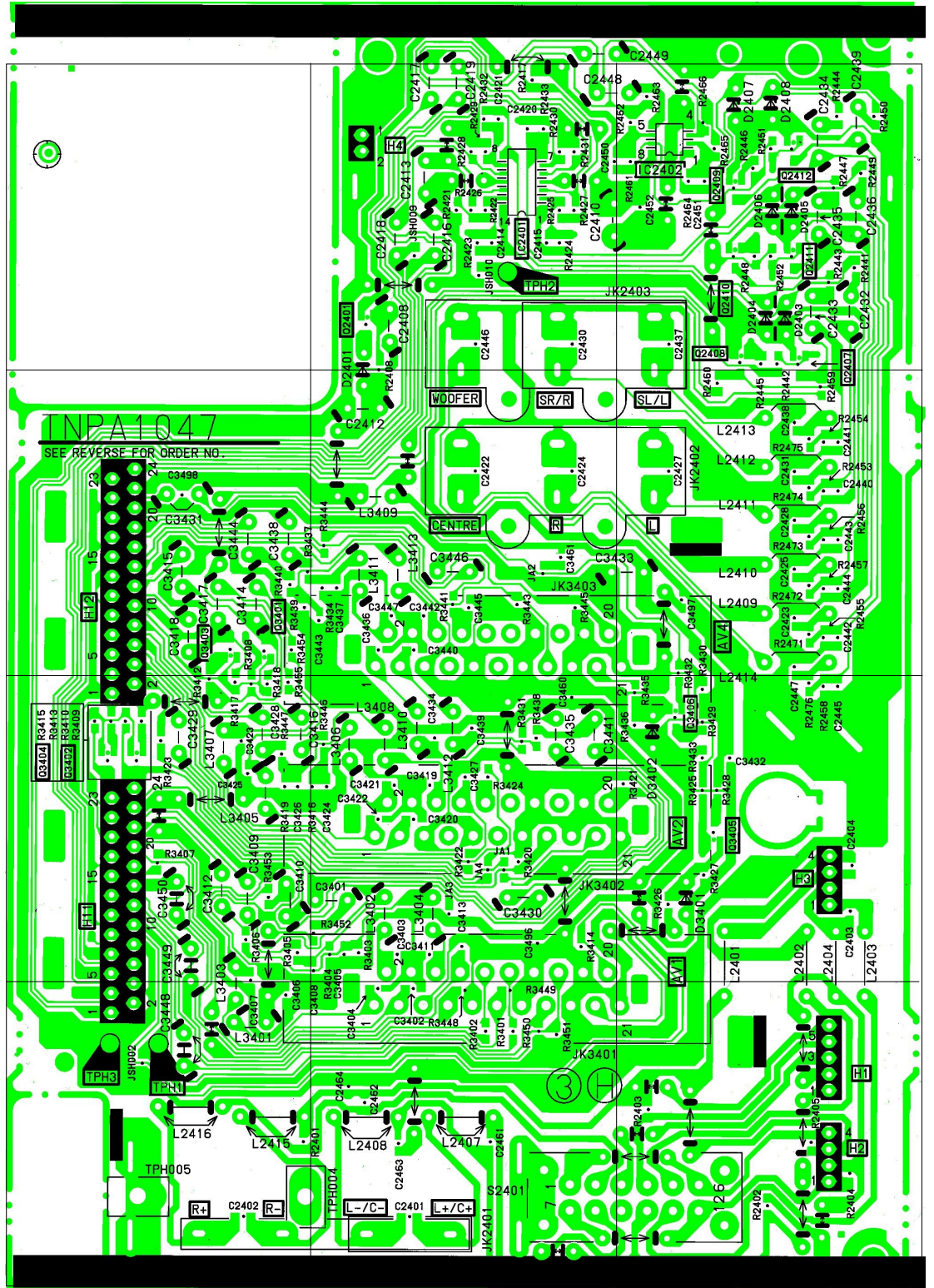

1

2

3

SCHEDA - F TNPA1068

TRAN'S	
Q1663	B2
Q1664	B2
Q1665	B2
Q1666	C1
Q1667	C1

I.C.'S	
IC1502	B3
IC1503	C3
IC1504	D1
IC1505	D2
IC1506	C2
IC1509	C1
IC1510	C1

A

B

C

D

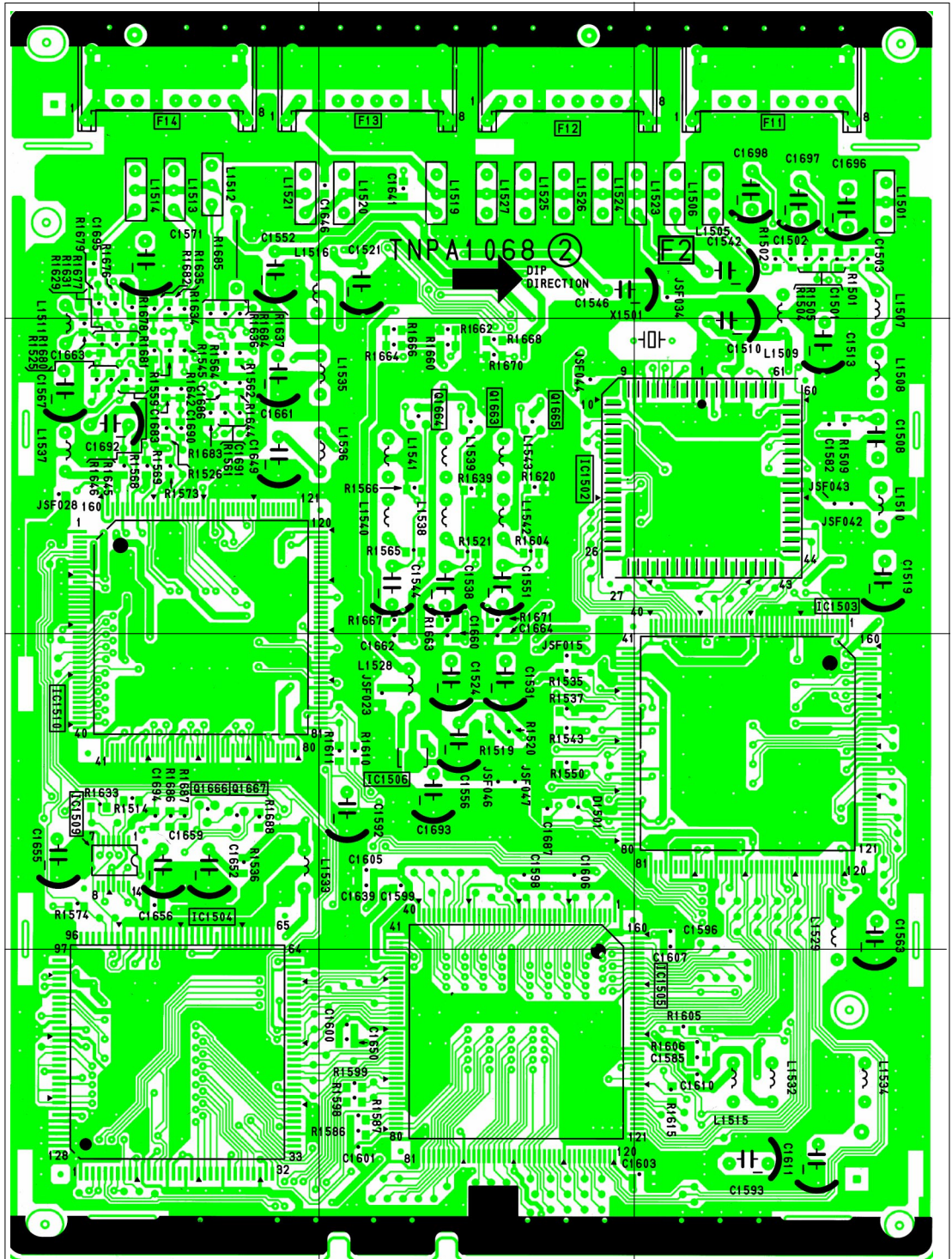

1

2

3

SCHEDA - F TNPA1068

TRAN'S	
Q1501	D3
Q1502	C3
Q1503	B2
Q1504	C1
Q1505	C1
Q1506	C1
Q1507	C1
Q1508	C1
Q1509	C1
Q1510	D1
Q1511	D1
Q1519	D1
Q1660	C2
Q1661	C2
Q1662	C2
I.C.'S	
IC1507	B2

A

B

C

D

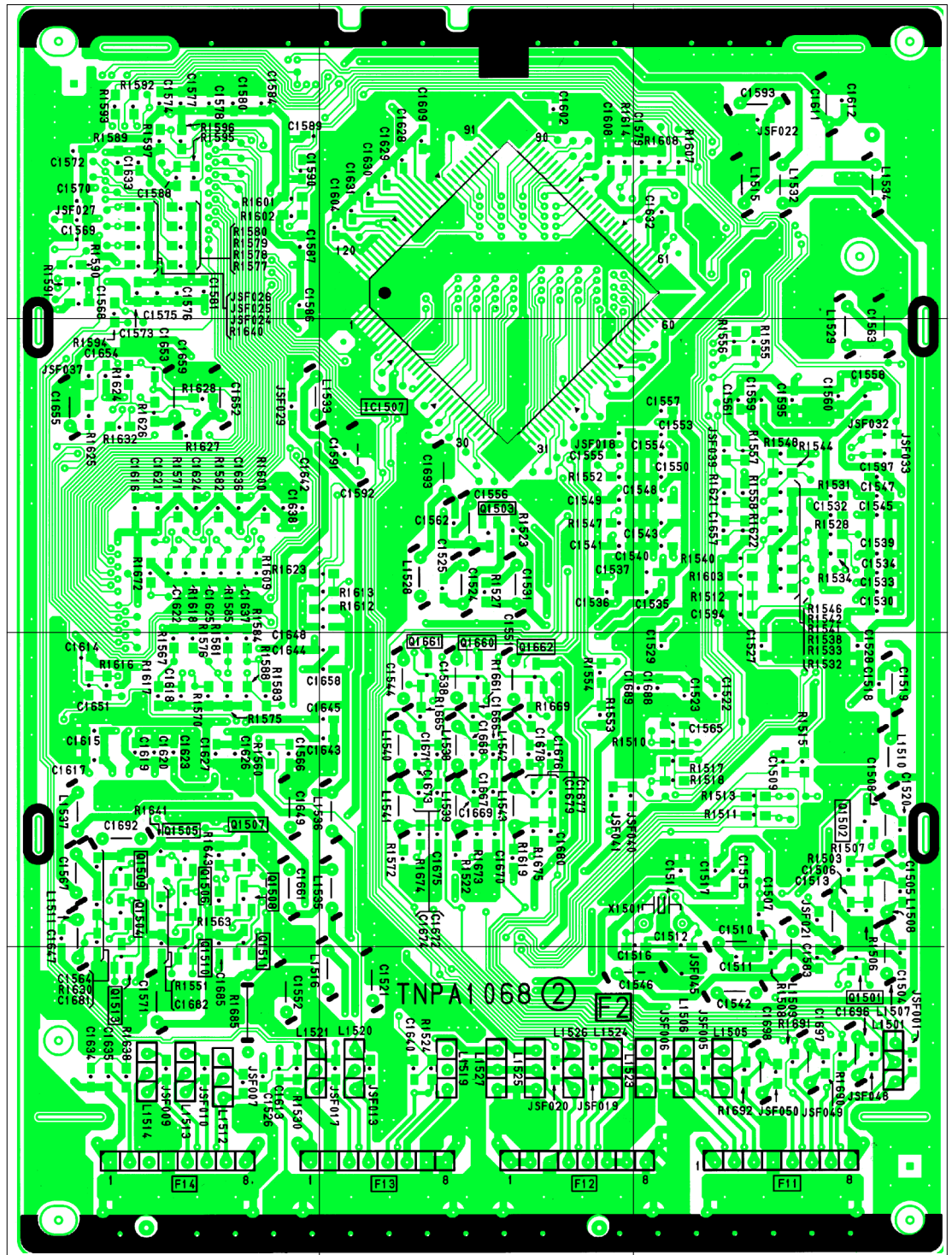

1

2

3

SCHEDA - M TNP8EM022

TRANSISTORS	
Q1011	A2
Q1012	B1
DIODES	
D1011	A2
D1012	A7
D1013	A7
D1014	A5
D1015	B6
D1016	A5
D1017	A5
IC'S	
IC1011	A1

